

JUMPKING[®]

Trampolines

User Guide

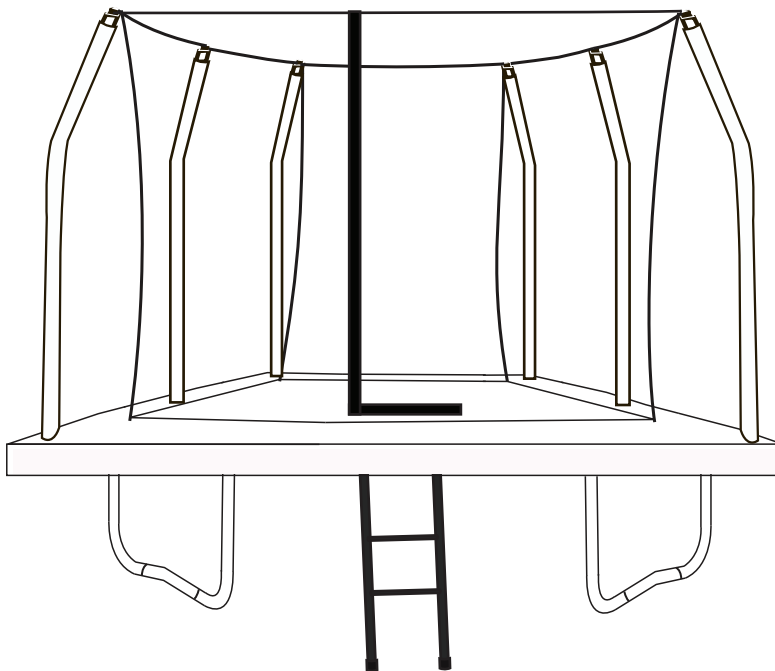

Model: JK710R6C1

7 ft x 10 ft Rectangle Trampoline & Enclosure

The trampoline / enclosure is designed for users weighing 90kg (200lbs) or less.

**Got a Problem building your trampoline?
Please contact us at contact@jumpking.com**



WARNING: Read these assembly instructions carefully before attempting to assemble or use this product. Keep this user guide in a safe place for future reference.

JUMPKING®

7 ft x 10 ft Rectangle Trampoline & Enclosure

QUESTIONS?

If you have questions after reading this manual, please email us at contact@jumpking.com. The trained technicians will provide immediate assistance.

REPLACEMENT PARTS

To order replacement parts, please visit our website at www.jumpking.com.

More detailed instructions on assembling their trampoline may be available on www.jumpking.com in the Manual and Assembly section.

CONTENTS

| | |
|---|----|
| IMPORTANT PRECAUTIONS | 4 |
| WARNING LABEL PLACEMENT | 6 |
| BEFORE YOU BEGIN | 7 |
| TRAMPOLINE/ENCLOSURE SAFETY INFORMATION | 7 |
| USE AND INSTRUCTIONAL MATERIAL | 11 |
| PART LIST | 16 |
| ASSEMBLY | 17 |
| CARE AND MAINTENANCE | 30 |

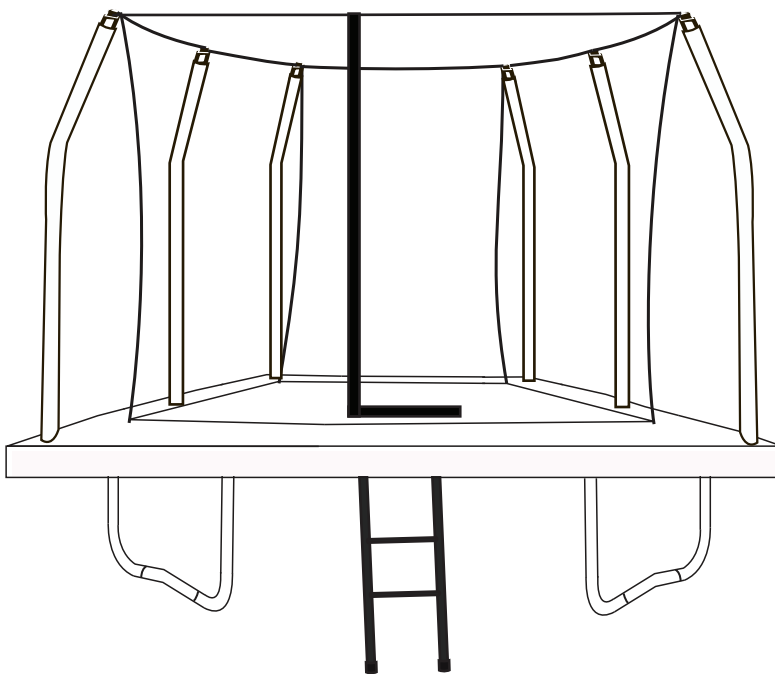

IMPORTANT PRECAUTIONS

⚠ WARNING: To reduce the risk of serious injury, read and follow all warnings, precautions, and instructions in this manual before assembling and using the trampoline.

1. Trained Spotter supervision is recommended.
2. Must place the trampoline on lawn, bark wood chip, sand or cushioning materials.
3. Maintain a free space of minimum 2500mm on all sides of the trampoline. This area should not include concrete, bitumen, brick, or other hard surfaces as these can cause serious injuries.
4. Adequate overhead clearance is essential. A minimum of 24 ft from ground level is recommended. Provide clearance for wires, tree limbs, and other possible hazards.
5. Lateral clearance is essential. Place the trampoline and trampoline enclosure away from walls, structures, fences, and other play areas. Maintain a clear space on all sides of the trampoline and trampoline enclosure.
6. Place the trampoline and trampoline enclosure on a level surface before use.
7. Use the trampoline and trampoline enclosure in a well-lighted area. Artificial illumination may be required for indoor or shady areas.
8. Secure the trampoline and trampoline enclosure against unauthorized and unsupervised use.
9. Remove any obstructions from beneath the trampoline and trampoline enclosure.
10. The trampoline enclosure is only to be used as an enclosure for a trampoline of a size for which the enclosure is designed.
11. The owner and supervisors of the trampoline are responsible to make all users aware of practices specified in the use instructions.
12. DO NOT attempt or allow somersaults on the trampoline. Landing on the head or neck can cause serious injury, paralysis, or death, even when landing in the middle of the bed.
13. Do not allow more than one person on the trampoline and trampoline enclosure. Use by more than one person at the same time can result in serious injuries.
14. Use trampoline and trampoline enclosure only with mature, knowledgeable supervision.
15. Trampoline over 20 in. (51 cm) tall are not recommended for use by children under 6 years of age.
16. The trampoline is designed for users weighing 90 kg (200 lbs.) or less.
17. Misuse and abuse of the trampoline is dangerous and can cause serious injuries.
18. Injury may result from encountering the frame or falling through the springs while getting onto or off the trampoline or while jumping. Stay in the center of the bed when jumping. Do not use the trampoline without the frame pad securely in place to cover the frame. The frame pad is not designed or intended to support the weight of the user. Do not step or jump directly onto the frame pad.
19. The trampoline is a rebounding device that propels the user to unaccustomed heights and into a variety of body movements. Rebounding off the trampoline, striking the frame or springs, or improperly landing on the bed may cause injury.
20. Do not jump on the trampoline while holding an object, particularly one that is sharp or breakable.
21. Inspect the trampoline and trampoline enclosure before each use. Make sure the frame padding, barrier and the enclosure support (frame) padding is correctly and securely positioned. Replace any worn, defective, or missing parts.
22. Climb on and off the trampoline. It is a dangerous practice to jump from the trampoline to the floor or ground when dismounting, or jump onto the trampoline when mounting. Do not use the trampoline as a springboard to other objects.
23. Stop bounce by flexing knees as feet come in contact with the trampoline bed. Learn this skill before attempting others.

24. Learn fundamental bounces and body positions thoroughly before trying more advanced skills. A variety of trampoline activities can be carried out by performing the basic fundamentals in various series and combinations, performing one fundamental after another, with or without feet bounces between them.
25. Avoid bouncing too high. Stay low until bounce control and repeated landing in the center of the trampoline can be accomplished. Control is more important than height.
26. While keeping the head erect, focus eyes on the trampoline toward the perimeter. This will help control bounce.
27. Avoid bouncing when tired. Keep turns short.
28. Properly secure the trampoline when not in use. Protect it against unauthorized use. If a trampoline ladder is used, the supervisor should remove it from the trampoline when leaving the area to prevent unsupervised access by children under 6 years of age.
29. Keep objects away which could interfere with the performer. Maintain a clear area around the trampoline.
30. Do not use the trampoline while under the influence of alcohol or drugs.
31. For additional information concerning the trampoline equipment, please email to contact@jumpking.com
32. For information concerning skill training, contact a certified trampoline instructor.
33. Bounce only when the surface of the bed is dry. Wind or air movement should be calm to gentle. The trampoline must not be used in gusty or severe winds.
34. Read all instructions before using the trampoline and trampoline enclosure. Warnings and instructions for the care, maintenance, and use of this trampoline and trampoline enclosure are included to promote safe, enjoyable use of this equipment.
35. Users may become entangled in or strangled by loose cords or in gaps between trampoline and enclosure.
36. Keep enclosure tightly fastened to the trampoline in accordance with manufacturer's instructions. Failure to properly assemble and maintain a tight, secure trampoline/enclosure boundary may result in serious injury, strangulation, or death.
37. Do not attempt to jump over the barrier.
38. Do not attempt to crawl under the barrier.
39. Do not intentionally rebound off the barrier.
40. Do not hang from, kick, cut, or climb on the barrier.
41. Wear clothing free of drawstrings, hooks, loops or anything that could get caught while using the trampoline/enclosure and result in entanglement or strangulation, or both.
42. Do not attach anything to the barrier that is not a manufacturer-approved accessory or part of the enclosure system.
43. Enter and exit the enclosure only at the enclosure door or barrier opening designated for that purpose.
44. The trampoline frame and the enclosure are made of metal. They are not grounded, and they will conduct electricity. Therefore, an electrocution hazard exists.
45. Keep all frame and heat sources away from the product.
46. Do not use or stand near the trampoline in windy or gusty conditions. A trampoline can become airborne when exposed to sustained wind or gusting wind conditions. This can result in serious injury, paralysis, or death, as well as property damage. To reduce these risks, disassemble the trampoline and enclosure and store them until weather conditions improve. Anchoring a trampoline frame may prevent the trampoline from moving as a result of the wind, but even anchored trampoline can become airborne or damaged. Consult a qualified contractor to determine what type of anchor works best in your location.
47. Ladder lets young children climb onto trampoline.
48. Do not use ladder if children under six might be nearby.
49. Remove the ladder when trampoline is not in use.

WARNING LABEL PLACEMENT

Label 1

Use trampoline only with mature, knowledgeable supervision. This trampoline is not recommended for children under 6 years of age.

Label 2

Use trampoline only with mature, knowledgeable supervision. This trampoline is not recommended for children under 6 years of age. Read instructions before using this trampoline. Inspect before using and replace any worn, defective or missing parts. N'utilisez ce trampoline que sous la supervision d'une personne responsable et informée. Ce trampoline n'est pas recommandé pour les enfants de moins de 6 ans. Lisez les instructions avant d'utiliser ce trampoline. Inspectez et remplacez toute pièce usée, ayant un défaut ou manquante avant utilisation.

Maximum User Weight
Poids maximum de l'utilisateur
50kg (200lbs)
YJ USA Corp.
3970 Lindbergh Drive Addison, TX 75001
Service client: contact@jumpking.com

TRAMPOLINE SAFETY INSTRUCTIONS

WARNING

Do not attempt or allow somersaults. Serious injuries, paralysis, or death may result. To reduce the chance of landing on your head or neck, do not do somersaults (flips).

Do not allow more than one person on the trampoline at a time. Multiple jumpers increase the chances of loss of control, collision, and falling off. This can result in serious injury to head, leg or neck.

For the Supervisor
Read instructions before use.
Use trampoline only with mature, knowledgeable supervision.
Not recommended for children under 6 years of age.
Inspect before use. Keep frame padding in place. Do not use when trampoline is wet or in a windy conditions.
Keep objects away which could interfere with the performer.
Secure the trampoline against unauthorized use.

For the Jumper
Do not use the trampoline while under the influence of alcohol or drugs.
Avoid bouncing when tired.
Jumping
Learn fundamental bounces and body positions thoroughly.
Stop bounce by flexing knees as feet come in contact with the bed.
Avoid bouncing too high. Maintain control.
Bounce in the center of the bed.
While keeping the head erect, focus eyes on the trampoline toward the perimeter.

Getting on and off
Climb on and off the trampoline. Do not use the trampoline as a springboard.
For skill training information, contact a trainer certification organization.
For Equipment Information, Contact: YJ USA Corp., 3970 Lindbergh Drive Addison, TX 75001. Customer service: contact@jumpking.com, Monday-Friday, 9 a.m. - 5 p.m.

ATTACH TO TRAMPOLINE

Placard
(to be attached by the owner)

The placard shown at the right must be attached to the trampoline enclosure by the owner.

If the placard is missing or illegible, please email contact@jumpking.com to order a free replacement placard. Note: The placard shown is not actual size.

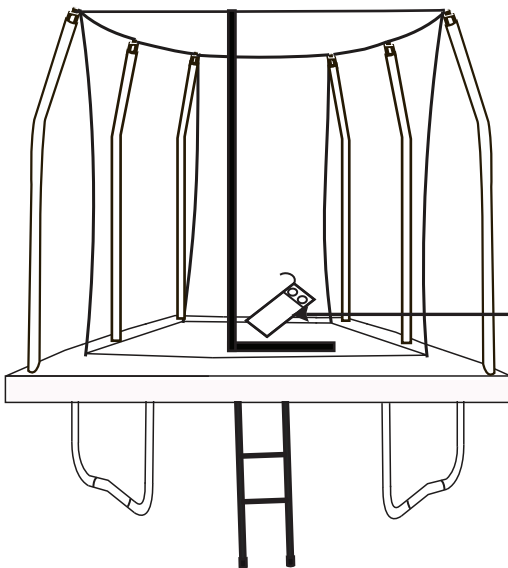

TRAMPOLINE ENCLOSURE SAFETY INSTRUCTIONS

WARNING

Do not land on head or neck. Paralysis or death can result, even if you land in the middle of the trampoline mat (bed). Do not do somersaults (flips).

Do not allow more than one person at a time in the trampoline enclosure. Multiple jumpers increase the chances of loss of control and this can result in broken head, neck, back, or leg.

Avoid bouncing when tired. While keeping the head erect, focus eyes on the trampoline toward the perimeter.

This trampoline enclosure system is not recommended for use by children under 6 years of age.

For the Supervisor
Inspect the trampoline before using. Keep frame pad in place. Do not use when trampoline is wet or in a windy conditions. A worn or damaged mat (bed), spring, or frame piece should be replaced immediately.
Keep objects away that could interfere with the jumper.
Secure the trampoline against unauthorized use.
Use trampoline enclosure only with mature, knowledgeable supervision. Enforce all safety rules and be familiar with the information in the User's Manual to help users in following trampoline enclosure instructions and trampoline safety.
Do not exceed the weight limit recommended by the manufacturer.
Use only when the enclosure barrier has no holes, pole clamps are tightly secured to the poles and the support (frame), and the barrier is properly suspended.
Do not intentionally rebound off the barrier. Do not hang from, kick, cut, or climb on the barrier.
Wear clothing free of drawstrings, hoods, loops, or anything that could get caught while using the trampoline/enclosure and result in entanglement or strangulation, or both.
Do not attach anything to the barrier that is not a manufacturer approved accessory or part of the enclosure system.
Users may become entangled in or strangled by loose cords or in gaps between trampoline and enclosure.
Keep enclosure tightly fastened to the trampoline in accordance with the manufacturer's instructions. Failure to properly assemble and maintain a tight, secure trampoline/enclosure boundary may result in serious injury, strangulation or death.
Use only when the trampoline mat (bed) is clean and dry. Inspect the trampoline and trampoline enclosure prior to each use and replace any worn or damaged parts.

For the Jumper
Do not use the trampoline enclosure system when under the influence of drugs or alcohol.

Jumping
Learn fundamental jumps and body positions thoroughly before trying more advanced skills. Review the User's Manual to learn about how to do basic jumps.
Stop bounce by flexing knees as feet come in contact with the bed.
Avoid jumping too high or for too long. Always control your jump. Do not try to jump over the barrier.
Bounce in the center of the bed. While keeping the head erect, focus eyes on the trampoline toward the perimeter.
Do not jump from other objects, buildings, or surfaces, onto the trampoline, or into or over the trampoline enclosure.

Getting on and off
Climb on and off the trampoline at the enclosure door or barrier opening. Do not jump on or off. Do not crawl under the barrier. Do not use the trampoline as a springboard to other objects.
For skill training information, contact a trainer certification organization.
For Equipment Information, Contact: YJ USA Corp., 3970 Lindbergh Drive Addison, TX 75001. Customer service: contact@jumpking.com, Monday-Friday, 9 a.m. - 5 p.m.

ATTACH TO NETTING AT DOOR

BEFORE YOU BEGIN

Thank you for selecting a Jumpking trampoline / enclosure. "Jumpking" is designed and crafted to provide many years of fun and fitness. This trampoline/enclosure comes equipped with warnings and instructions for the assembly, care, maintenance and use of the trampoline/enclosure. This information must be read by all trampoline supervisors and users before any person is allowed to use the trampoline/enclosure.

If you have questions after reading this manual, please visit our website at www.jumpking.com. To help us assist you, please mention the name of the product when calling.

TRAMPOLINE SAFETY INFORMATION

In trampoline use, as in all active recreational sports, participants can be injured. However, there are steps that can be taken to reduce the risk of injury. In this section, primary accident patterns are identified and the responsibilities of supervisors and jumpers in accident prevention are described.

ACCIDENT CLASSIFICATION

Somersaults (flips): Landing on your head or neck, even in the middle of the trampoline bed, increases the risk of a broken back or neck, which can result in paralysis or death. Such events can occur when a jumper makes an error trying to perform a forward or backward somersault (flip). Do not perform somersaults (flips) on this backyard trampoline.

Multiple Jumpers: More than one jumper on the trampoline increases the chance of a jumper becoming injured by losing control of his or her jump. Jumpers may collide with one another, fall off the trampoline, fall on or through the springs, or land incorrectly on the bed. The lightest weight jumper is the jumper most likely to be injured.

Mounting and Dismounting: The trampoline bed is several feet from ground level. Jumping off the trampoline to the ground or any other surface may result in injury. Jumping onto the trampoline from a roof, deck, or other object also represents a risk of injury. Smaller children may need assistance getting onto or down from the trampoline. Climb carefully onto and off the trampoline. Do not step onto the springs or the frame pad. Do not grasp the frame pad to pull yourself onto the trampoline.

Striking the Frame or the Springs: Injury may result from encountering the frame or falling through the springs while jumping or getting onto or off the trampoline. Stay in the center of the bed when jumping. Make sure to keep the frame pad in place to cover the frame. The frame pad is not designed nor intended to support the weight of the trampoline user. Do not step or jump directly onto the frame pad.

Loss of Control: Jumpers who lose control of their jump may land on the bed incorrectly, land on the frame or springs, or fall off the trampoline. A controlled jump is one where the landing is in the same spot as the takeoff. Before learning a more difficult maneuver, the preceding one should be performed consistently under control. Attempting a maneuver beyond present skill levels increases the chance of loss of control. To regain control and stop your jump, bend your knees sharply when you land.

Alcohol or Drug Use: The chance of injury increases when a jumper has consumed alcohol or taken drugs. These substances impair a person's reaction time, judgment, and physical coordination.

Encountering Objects: Use of a trampoline while other people, pets, or objects are underneath it will increase the chance of injury. Jumping while holding or having an object on the trampoline, particularly one that is sharp or breakable, will increase the chance of injury. Placing a trampoline too close to overhead electrical wires, tree limbs, or other obstructions can increase the chance of injury.

Poor Maintenance of the Trampoline: Jumpers may be injured if a trampoline is used when it is in poor condition. A torn bed, bent frame, broken spring, or missing frame pad, for example, should be replaced before anyone is allowed to jump. Inspect the trampoline before each use.

Weather Conditions : A wet trampoline bed is too slippery for safe jumping. Gusty or high winds can cause jumpers to lose control. To reduce the chance of injury, use the trampoline only under appropriate weather conditions.

Access: To prevent access to the trampoline by unsupervised smaller children, the access ladder should always be removed and stored in a secure location when the trampoline is not in use.

METHODS OF ACCIDENT PREVENTION

The Supervisor's Role in Preventing Accidents

It is the responsibility of the supervisors of trampoline users to provide knowledgeable and mature supervision. They need to know and enforce all the rules and warnings set forth in this manual to minimize the likelihood of accidents and injuries and to inform users of these rules. During periods of time when supervision is unavailable or inadequate, this may require that the trampoline be disassembled, placed in a secure area, or otherwise secured against unauthorized use. Another option that may be considered is covering the trampoline with a heavy tarp that can be secured with locks and chains.

The Jumper's Role in Preventing Accidents

Education on the part of the user is a must for safety. Users must first learn a low, controlled bounce and then learn the basic landing positions and combinations before proceeding to intermediate skills. Jumpers must understand why they have to master "control" before they can start thinking about other moves. Understanding the proper progression of skills in jumping on a trampoline must be the first lesson. Review this manual to learn about the basic techniques for using the trampoline. For further information or additional instructional materials, contact a certified trampoline instructor.

TRAMPOLINE SAFETY INSTRUCTIONS

For the Supervisor

Read the instructions before using the trampoline. Enforce all of the safety rules and be familiar with the information in this manual to help new users learn basic jumps and all users follow trampoline safety. All trampoline users must have mature, knowledgeable supervision, regardless of the skill or age of the jumper.

This trampoline is not recommended for use by children under 6 years of age.

Inspect the trampoline before using it. Do not use the trampoline without the frame pad securely in place to cover the frame. Do not use the trampoline when it is wet or in a windy condition. A worn or damaged bed, spring, or frame piece should be replaced immediately.

Keep objects away that could interfere with the jumper.

Secure the trampoline against unauthorized and unsupervised use.

For the Jumper

Do not use the trampoline when under the influence of drugs or alcohol.

Avoid bouncing when tired.

JUMPING

Learn fundamental jumps and body positions thoroughly before trying more advanced skills. Be alert to your own limitations in the execution of trampoline skills. Review this manual to learn how to do basic jumps.

Stop your bounce by flexing your knees as your feet come in contact with the trampoline bed. Learn this skill before attempting others.

Avoid jumping too high or for too long. Always control your jump. A controlled jump is one where the takeoff and landing spots are the same.

Bounce in the center of the trampoline. Focus your eyes on the frame pad. Failure to do so may result in a loss of balance and control.

Take turns jumping, one at a time, and always have someone watch you.

GETTING ON AND OFF

Climb onto and off the trampoline; do not jump onto it or off it. Do not use the trampoline as a springboard to other objects. For additional information regarding skill training, contact a trainer certification organization.

TRAMPOLINE ENCLOSURE SAFETY INFORMATION

NEED FOR TRAMPOLINE ENCLOSURE SAFETY

A trampoline enclosure is a recreational product.

The information on this page and on page 10 identifies important safety precautions. The precautions are not all-inclusive, because an enclosure can be used in ways that this manual cannot cover completely.

To prevent pinches and cuts during enclosure use, a frame pad must be installed on the trampoline. (See the trampoline manufacturer's instructions.) The frame pad must be installed before the enclosure is erected. The frame pad reduces the chance of injury from accidental contact with the springs and frame.

USING THE ENCLOSURE SAFELY

Adult Supervision of Children

Children using a trampoline with a trampoline enclosure must be supervised by adults. Young children must be supervised constantly. Adults must pay particular attention to:

- things that children bring into the enclosure.
- children's activities inside the enclosure.
- conditions inside the enclosure while children are using it.
- the way children get into and out of the enclosure.

Additional details of safe enclosure use are described below.

Electrocution Hazard Associated with the Metal Frame of the Trampoline and Enclosure

The trampoline and enclosure frames are made of metal. They are not grounded, and they will conduct

electricity. Lights, electric heaters, extension cords, and household electrical appliances are not permitted in or on the trampoline or enclosure.

Hazards Associated with Entering and Exiting the Trampoline Enclosure

A trampoline enclosure installed on a trampoline is raised off the ground. The height of the enclosure increases the risk of a fall when a jumper is entering or exiting the enclosure. Young children in particular may have difficulty getting into and out of the enclosure. To reduce the risk of falling, help young children to get into and out of the enclosure.

Enter and exit the trampoline enclosure only through the door of the enclosure (the opening in the netting walls). The trampoline bed and the netting walls of the enclosure are separate pieces; jumpers, particularly young children, must not exit the enclosure by going out between the bed and the netting walls. Trying to exit in this way poses a risk of strangulation from being caught between the trampoline frame and the netting walls.

Darkness increases the chances of a fall when a jumper is entering or exiting the enclosure. Do not use the trampoline unless adequate lighting is provided.

Hazards Associated with Animals and Sharp and Breakable Objects

To avoid damage to the trampoline enclosure and the trampoline, do not allow pets or other animals inside of the enclosure. The claws and teeth of animals can damage the netting. Do not jump on the trampoline while holding or wearing a sharp or breakable object.

Hazards Associated with High Winds

A trampoline with an enclosure can be moved or blown over by high winds, potentially injuring anyone in its path or anyone inside of the enclosure. If you anticipate high winds, take down the enclosure netting, and stake the trampoline frame to the ground (see page 22), or move the trampoline and enclosure to a sheltered location.

Storing the Trampoline Enclosure Safely

Specific steps for storing the trampoline enclosure are presented later in this manual. There are specific safety precautions to be aware of when storing the enclosure.

Remove the attached tube sections as a unit, and separate them on the ground. Avoid pinching your fingers by keeping your fingers away from pinch points near the bracket assembly while you are removing the tubes from the frame.

Placing the Trampoline in a Safe Place

There must be at least 7.3 m (24 ft.) of clear, open space above the trampoline bed. Do not place or store anything underneath the trampoline.

To avoid injury, the trampoline must be kept away from objects and possible hazards including electric power wiring, tree limbs, and fences. Do not place the trampoline near any other recreational devices or structures such as a swimming pool or swing set.

The trampoline must be placed on a level surface before use, and the area around the trampoline must always be well lighted.

For the Supervisor

Be familiar with the information in this manual and enforce all of the safety rules. Help new users and all users to use the trampoline and enclosure safely.

All trampoline users must have someone watch them, regardless of the skill or age of the user.

Secure the trampoline against unauthorized and unsupervised use. Keep the trampoline free of objects that could interfere with the jumper.

This trampoline enclosure is not recommended for use by children under 6 years of age or by anyone weighing more than 90 kg (200 lbs.).

Use the trampoline only when the bed is clean and dry. Inspect the trampoline and enclosure prior to each use and replace any worn or damaged parts. Use only when the enclosure netting has no holes, the clamps are tightly secured to the tubes and the frame, and the netting is properly suspended.

For the Jumper

Do not use the trampoline enclosure when under the influence of drugs or alcohol.

Avoid jumping too high or for too long. Always control your jump.

Take turns jumping one at a time, and always have someone watch you.

Do not attempt to jump over the netting. Do not intentionally rebound off the netting. Do not hang from, kick, cut, or climb on the netting.

Wear clothing that is free of drawstrings, hooks, loops or anything that could get caught in the netting.

Do not attach anything to the netting that is not an approved accessory or part of the trampoline enclosure.

How to Enter and Exit the Trampoline Enclosure

Enter and exit the trampoline enclosure only through the door in the netting. To enter the enclosure, first unfasten the plastic clips on the door and unzip the zippers. Place one knee on the frame pad and climb head first through the door. Refasten the plastic clips and close the zippers.

To exit the enclosure, first unzip the zippers on the door and unfasten the plastic clips. Sit on the bed of the trampoline and climb feet first through the door. When you are through the door and sitting on the frame pad, step or jump safely to the ground. Close the zippers and refasten the plastic clips.

USE AND INSTRUCTIONAL MATERIAL

OVERVIEW OF TRAMPOLINE USE

The first periods of trampoline use should focus on learning fundamental body positions and practicing the eight basic bounces that are described on pages 13 and 14 in this manual.

During this learning period, jumpers should practise these basic techniques and perfect them. Braking, or checking the bounce, should be taught first and stressed as a safety measure. Jumpers should brake their jump whenever they start to lose balance or control. This is done by simply flexing the knees sharply upon landing and absorbing the upward thrust of the bed. This enables the jumper to stop suddenly and avoid losing control.

In trampoline use, the takeoff point and landing point of a good, controlled jump are in the same spot. An exercise is considered learned only when a jumper is able to perform it consistently. Jumpers should never proceed to any advanced step until they can perform all previous techniques consistently.

Allow each jumper a brief turn on the trampoline. Extended bouncing exposes an overtired user to an increased risk of injury. Longer turns tend to lessen the interest of others waiting to jump. Clothing should consist of a T-shirt and shorts. Jumpers should wear regulation gymnastic shoes or heavy socks, or they may jump barefoot. Street shoes or tennis shoes

should not be worn on the trampoline. Beginning jumpers may wish to wear loose-fitting protective clothes, such as a long-sleeve shirt and pants, until correct landings are mastered. This will reduce the chance of mat (bed) burns from improper landings on elbows and knees. No hard-sole shoes should be worn, as they cause excessive wear on the trampoline bed.

Mounting and dismounting properly should be a strict rule from the beginning. Users should climb onto the trampoline by placing their hands on the frame and stepping or rolling up onto the frame, across the springs, and onto the bed. Do not step directly onto the frame pad or grasp the frame pad when mounting or dismounting the trampoline. Users should always place their hands on the frame while mounting or dismounting. To dismount, jumpers should walk to the side of the bed, bend over and place one hand on the frame, and then step from the bed to the ground. If you have installed the optional ladder, its rungs can be used to mount or dismount. Always face the ladder and place your hands on the frame. Make sure your foot has secure contact with the ladder rung when using it.

Reckless bouncing should not be permitted. All skills should be learned at moderate heights. Control, rather than height, should be emphasized. Jumpers should be forbidden to practice alone and unsupervised.

INSTRUCTIONAL PROGRAM AND MODEL LESSONS

The following lessons are examples of an instructional program. They should follow a complete discussion and demonstration of body mechanics between the supervisor and the student(s). See pages 13 and 14 for descriptions of basic trampoline skills.

Lesson 1

1. Mounting and dismounting—Demonstration and practice of proper techniques.
2. Fundamental bounce—Demonstration and practice.
3. Braking (checking the bounce)—Demonstration and practice. Braking on command.
4. Hand and knee drop—Demonstration and practice, stressing four-point landing and alignment.

Lesson 2

1. Review and practice of skills previously learned.
2. Knee drop—Half twist to the right, to the left, to the feet, and then to the knees.
3. Seat drop—Half twist to the feet. Seat drop, knee drop, hand and knee drop, repeat.

Lesson 3

1. Review and practice of skills previously learned.
2. Front drop—To save time and avoid mat (bed) burns, all students should be requested to assume the front drop position on the floor while the instructor checks for faults. Suggested progression: from hand and knee bounce, the body is extended for the landing in the front drop position, and the rebound is made to the feet.
3. Practice routine—Hand and knee drop, front drop, feet, seat drop, half twist to feet.

Lesson 4

1. Review and practice of skills previously learned.
2. Back drop—Demonstration, emphasizing the forward thrust of the hips by arching the body as one

leg is brought forward from the standing (not bouncing) position, and the drop to the back with the chin held forward to the chest and the eyes forward on the frame pad. Spotting this skill is most important. Demonstration of back drop with low bounce and practice of both techniques.

Lesson 5

1. Review and practice of skills previously learned, encouraging original routines based on them.
2. Half turntable—Start from the front drop position and push to the left or right with the hands. Turn the head and shoulders in the same direction. Keep the back parallel to the bed and the head up. After completing a half turn, land in the front drop position.

Lesson 6

1. Swivel hips—Suggested progression: seat drop, feet, half twist, repeat; seat drop, half twist to feet, repeat; seat drop, half twist to seat drop.
2. Half turntable.

Lesson 7

The student should now be encouraged to design and organize routines, with emphasis on good form. The instructor may judge or grade students and arrange groupings for further instruction accordingly.

To stimulate interest in competition, the game of "Trampoline Horse" can be introduced. Before the game begins, students must count off. To start the game, student number 1 performs a stunt. Student number 2 then mounts the trampoline and performs the same stunt and adds a second stunt. Student number 3 mounts and performs stunts 1 and 2 and adds a third stunt. Thus, the series of stunts is continuously lengthened. The first person to miss a stunt in the series assumes the letter "H" and starts a new series with a stunt. If a person misses again, he assumes the letter "O." The first person to accumulate "H-O-R-S-E" is eliminated from the game. The last remaining contestant is the winner.

Lesson planning from this point should be facilitated by contacting a certified trampoline instructor.

BASIC TRAMPOLINE SKILLS

Fundamental Bounce

1. Start from a standing position with your head erect and your eyes on the frame pad.
2. Swing your arms forward and up in a circular motion.
3. Bring your feet together and point your toes downward while in the air.
4. Keep your feet about 30 cm (15 in.) apart when landing on the bed.

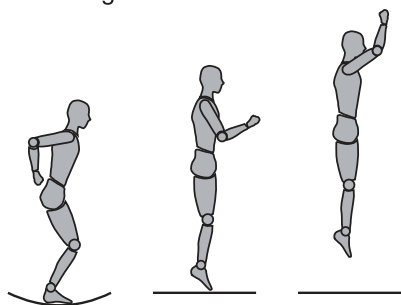

Knee Drop

1. Start bouncing from a standing position, keeping your eyes on the frame pad.
2. Land on your knees, keeping your back straight and your body erect.
3. Come back up to an erect position.

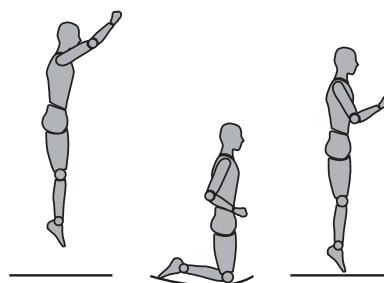

Hand and Knee Drop

1. Start bouncing from a standing position, keeping your eyes on the frame pad.
2. Land on the bed on your hands and knees.
3. Push with your hands and come back up to an erect position.

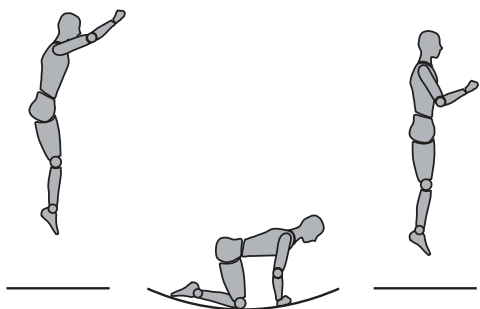

Back Drop

1. Start from a low bounce and land on your back.
2. Keep your chin forward on your chest as you land.
3. Kick forward and up with your legs to return to an erect position.

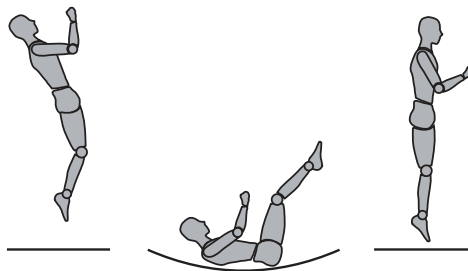

Seat Drop

1. Land in a sitting position with your legs parallel to the bed.
2. Place your hands on the bed beside your hips.
3. Push with your hands to return to an erect position.

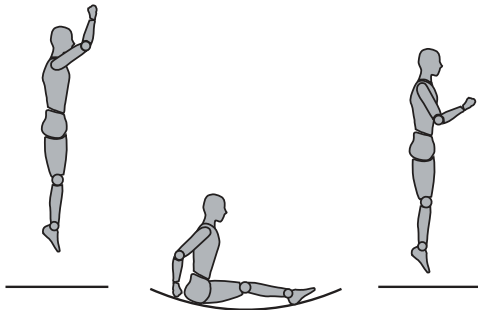

Front Drop

1. Start from a low bounce and land on the bed in a prone position.
2. Keep your head up and your arms extended forward on the bed.
3. Push with your arms to return to an erect position.

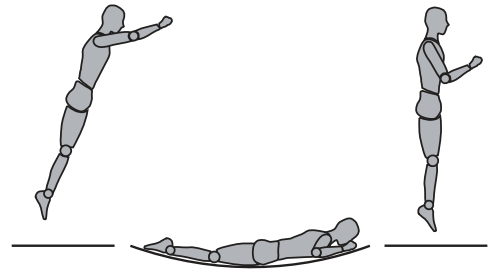

Half Turntable

1. Start from the front drop position and push to the left or right with your arms to begin turning your body in the opposite direction.
2. Turn your head and shoulders toward the direction that your body is turning.
3. Keep your back parallel to the bed and your head up.
4. After completing a half turn, land in the front drop position.

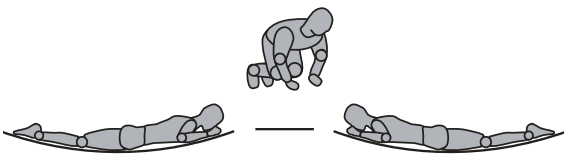

Swivel Hips

1. Start with a seat drop.
2. Turn your head to the left or right and swing your arms up in the same direction.
3. Turn your hips in the same direction as your head and arms, completing a twist.
4. Land in the seat drop position.

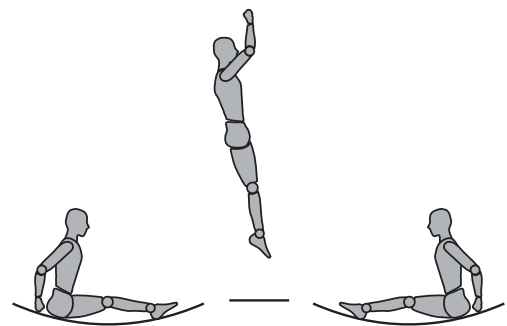

BUILDING YOUR TRAMPOLINE

1. This is a 2 person build.
2. Time for build is approximately 2 hours.
3. Choose a good location:
 - On a level surface that is soft (*wood chippings, sand or grass*).
 - Ensure adequate overhead clearance. A minimum of 24ft (7.3m) from ground level, away from wires, trees and other possible hazards.
 - Ensure a clear space of 8.2ft (2.5m) around sides, away from walls, fences, structures, asphalt and other hard surfaces and play areas.

WHAT YOU WILL NEED

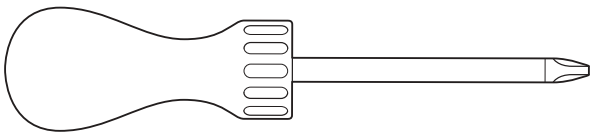

Description:
Phillips-head screwdriver

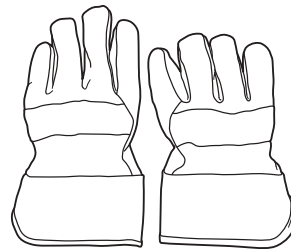

Description:
Gloves

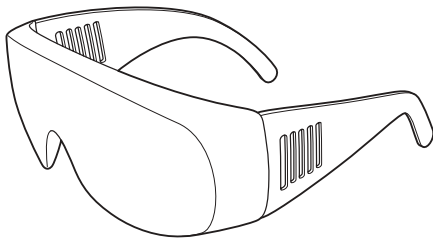



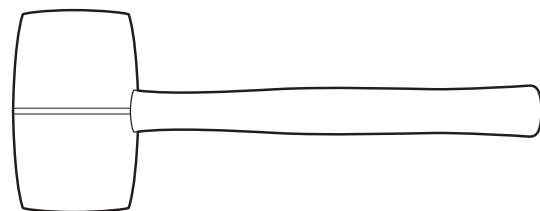





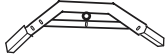
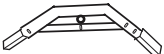







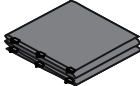

Description:
Safety glasses

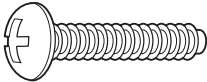
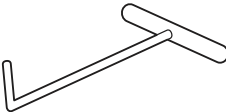
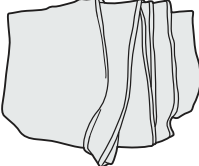
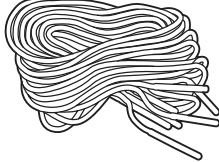

Description:
Mallet

PARTS LIST

| Part 1 | Part 2 | Part 3 | Part 4 | Part 5 |
|---|--|---|---|--|
|  Description: Corner tube A with Support connector Part# JK710R6-TRA Quantity: 2 |  Description: Corner tube E with Support connector Part# JK710R6-TRE Quantity: 2 |  Description: Top tube B Part# JK710R6-TRB Quantity: 2 |  Description: Top tube D Part# JK710R6-TRD Quantity: 2 |  Description: Top tube C Part# JK710R6-TRC Quantity: 2 |
|  Description: Top tube F Part# JK710R6-TRF Quantity: 2 |  Description: T-connector Part# JK710R6-TC Quantity: 8 |  Description: Support Connector (Have been preassembled to the Corner tubes A & E) Part#SC710C1 Quantity: 4 |  Description: L leg Part# JK710R6-LS Quantity: 8 |  Description: Center V leg Part# JK710R6-LC Quantity: 4 |
|  Description: Jumping Bed Part# BEDRC71058-5/3.5 Quantity: 1 |  Description: 5 inch Spring Part#SP5 Quantity: 54 |  Description: 3.5 inch Spring Part#SP3.5 Quantity: 4 |  Description: Safety Frame Pad Part# PADRC710JP6-10G Quantity: 1 |  Description: Enclosure Bottom Pole Part# E28B845P Quantity: 6 |
|  Description: Enclosure Top Pole Part# E28C845P7 Quantity: 6 |  Description: Self Tapping Screws Part#HWSTS Quantity: 14 |  Description: Spring Pulling Tool Part#HWSPT Quantity: 1 |  Description: Enclosure Netting Part# NETRC710-JP6/5JK Quantity: 1 |  Description: Cord Part# HWROPE-S8 Quantity: 6 |
|  Description: Foam Sleeve (Have been preassembled to the enclosure poles) Part#FSBLK44 Quantity: 12 |  Description: Enclosure pole cap (Have been preassembled to the enclosure poles) Part#HWEPC10.5-28 Quantity: 6 |  Description: Ladder Part#ACC-LADFS Quantity: 1 | | |

STEP 1 : ASSEMBLING THE FRAME

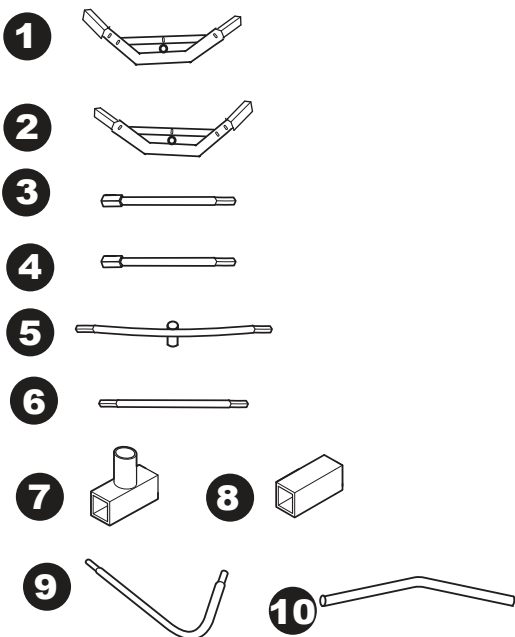

You will need the following parts to complete step 1.

- 2 x Corner tube A with Square Connector - Part 1
- 2 x Corner tube E with Square Connector - Part 2
- 2 x Top Tube B - Part 3
- 2 x Top Tube D - Part 4
- 2 x Top Tube C - Part 5
- 2 x Top Tube F - Part 6
- 8 x T-connector - Part 7
- 4 x Support Connector - Part 8
- 8 x L Leg - Part 9
- 4 x Center V Leg - Part 10

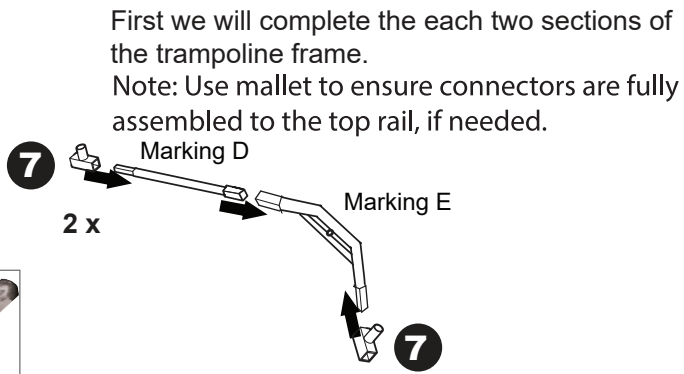
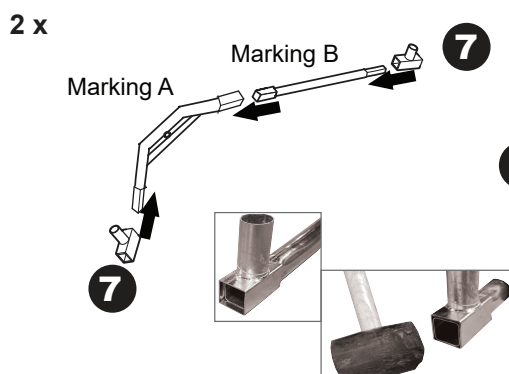

First we will complete the each two sections of the trampoline frame.
 Note: Use mallet to ensure connectors are fully assembled to the top rail, if needed.

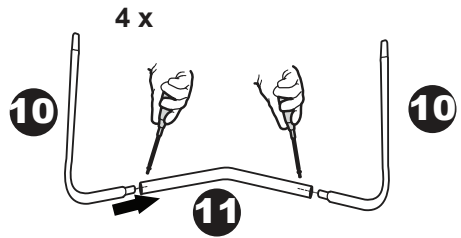

Connect the 4 sections of Center V leg and L leg.
 Screw the self tapping screw on L leg and Center V leg.

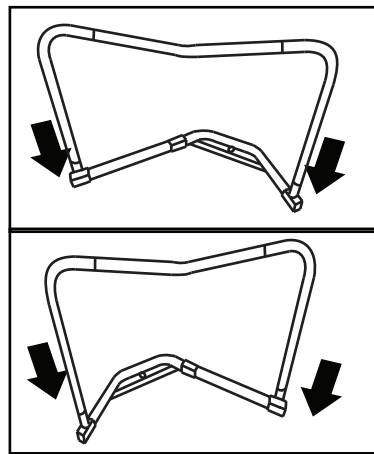

Insert the L leg and Center Leg into upright tube on T-connector.
 Note: You may need to tap the leg in using a rubber mallet or by placing a piece of wood over the top of the tube. Do not use metal hammer on the metal tube as this may distort the end of tube.

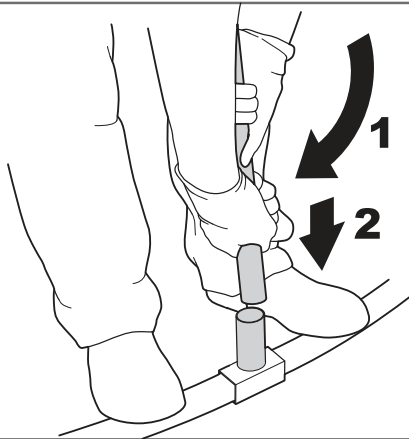

Important: The frame is held together under tension so you will have to use some force to insert certain parts.

Place your feet on the top tubes and grip the leg extension with both hands.

Pull the extension until it can be slotted into the T-connector.

Slot the end of leg extension into the T-connector.

Repeat the last two steps until you have assembled the remaining sections of the trampoline frame.

You have now completed step 1.

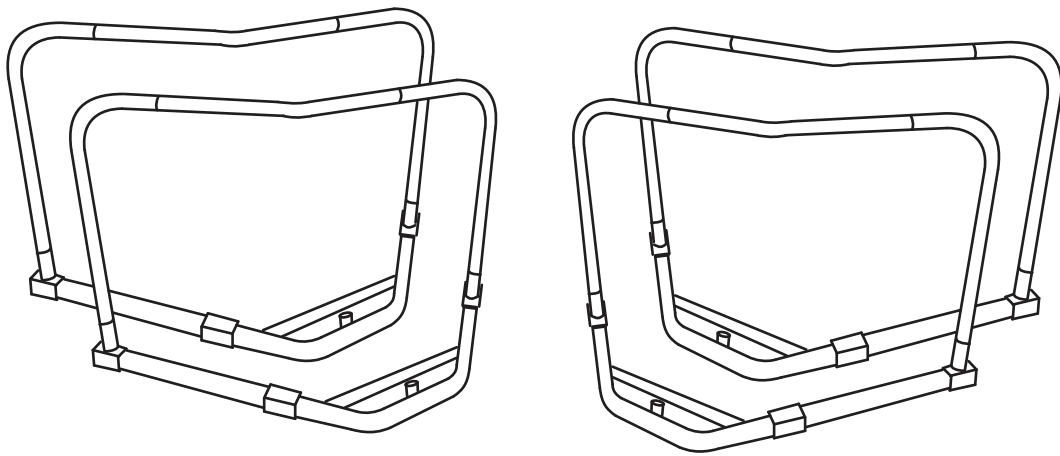

STEP 2 : ASSEMBLING THE FRAME

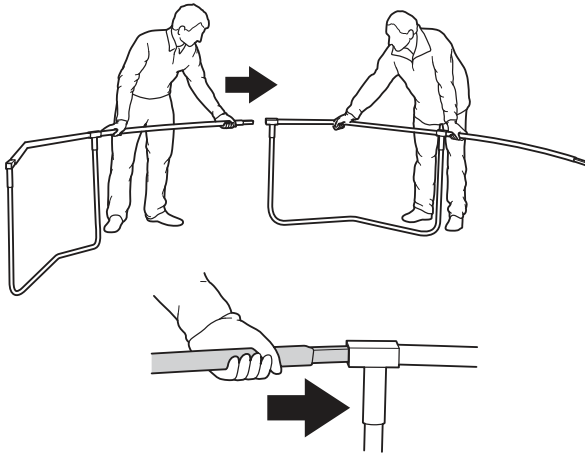

This step will require 2 people who must be wearing gloves.

Slot two of the frame sections together as shown in the diagram.

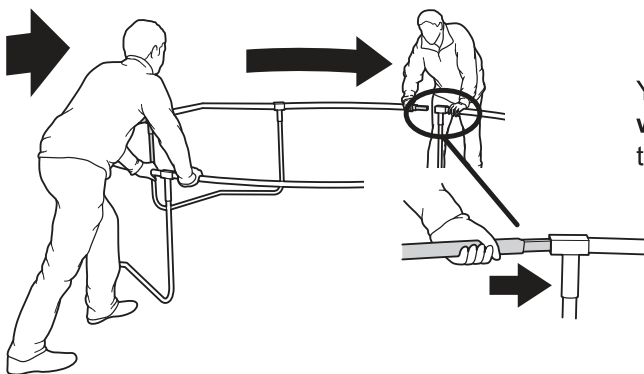

You will now need to slot the frame together, **this will take some force**. The easiest method is if the two people face each other.

Hold the top tubes either side of the T-connector+welded tubes and push towards each other until the loose end of the frame can be inserted into the T-connector.

Top view of frame:

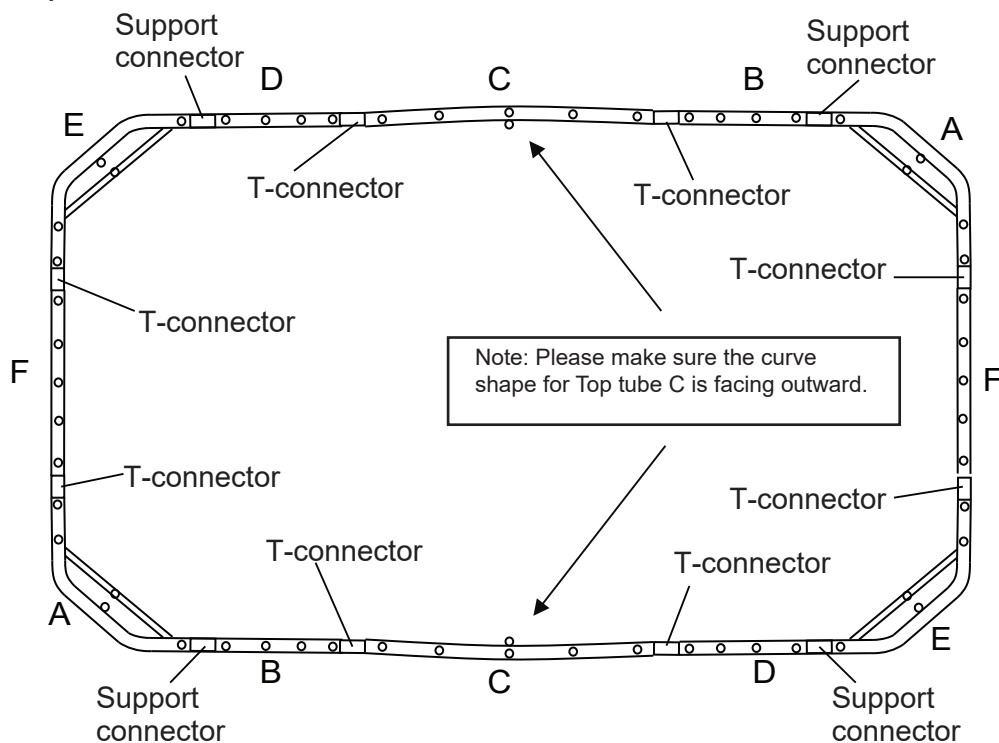

Important: Ensure all of the top tubes and legs are fully inserted.

The frame is now fully assembled and you have completed step 2.

STEP 3 : FITTING THE STITCHED BED

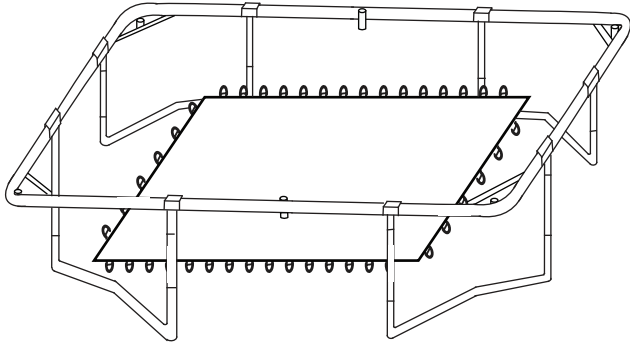

This step will require 2 people who must be wearing gloves and protective eye wear.

Lay the stitched bed (*with the V-Rings*) out inside the frame of the trampoline with the warning labels facing upwards.

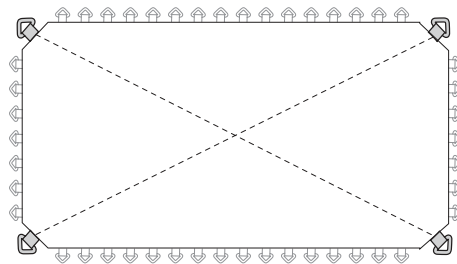

Locate the 4 v-rings at the 4 corners.

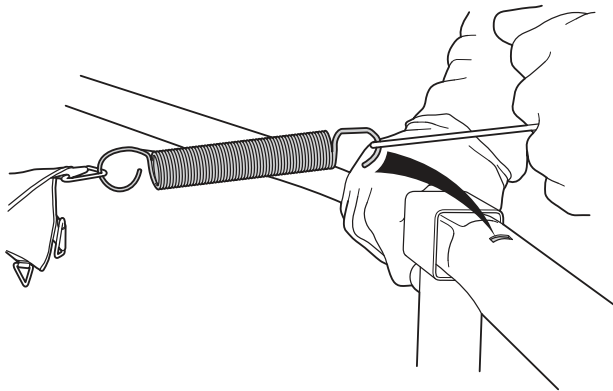

Important: You will now need to use the spring tool to attach the spring to the frame.

Hook the spring tool onto end of spring, and pull until the spring can be slotted into the spring slot on the top of the frame.

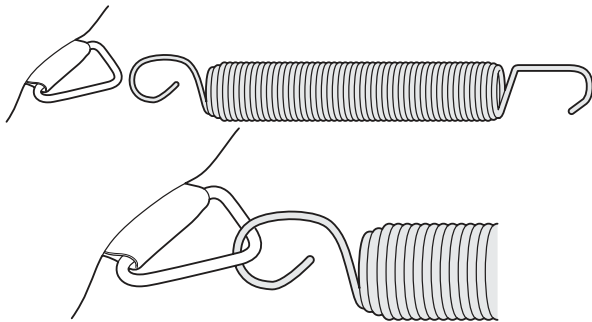

Slot the springs onto the V-rings as shown.

Important: Springs must be slotted on the correct way around.

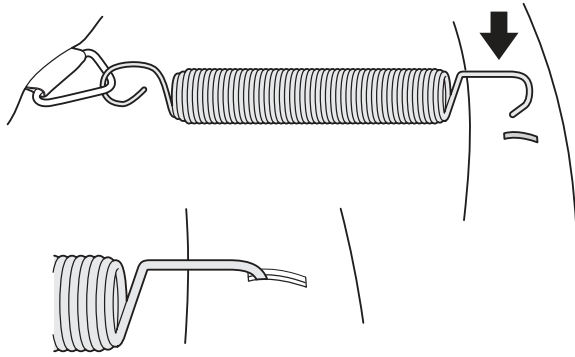

Slot the other end of the spring into one of the spring slots in the top of the frame.

IMPORTANT: Ensure the spring is fully inserted into the slot on the top of the frame.

Important: The stitched bed is designed like elastic to be bouncy, which means that during construction it may look like it won't fit. Please note that it will stretch to the correct size when attaching the springs, which may take some force.

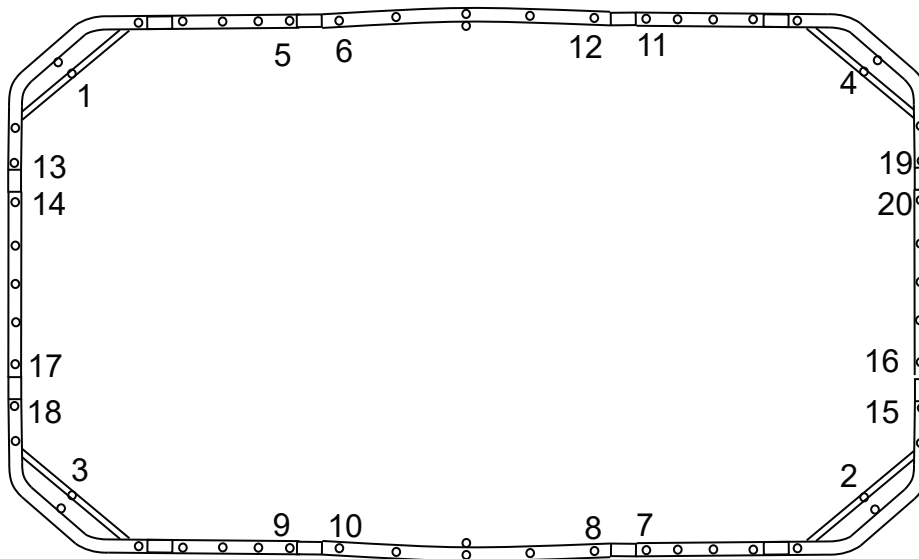

Lay out the bed (Part 11) on the floor within the frame, match the corner V rings with the corner spring holes. Please attach 4 pcs 3.5" springs (Part 13) on each corner number 1 through 4.

Then attach the 5" springs (Part 12) in the sequence shown either side of the T-Connector. Continue adding the remaining springs in the same sequence, making sure the next spring attached is on the opposite side to even out the tension.

STEP 4 : FITTING THE FRAME PAD

14

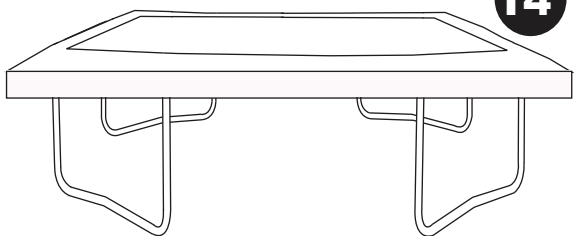

This step will require 2 people.

Lay the frame pad - **Part 14** out over the edge of the frame with the ties facing downwards.

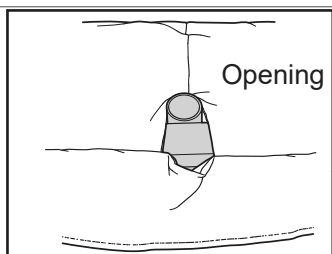

Opening

Align the openings in the frame pad with the T-connector with welded tubes on the frame.

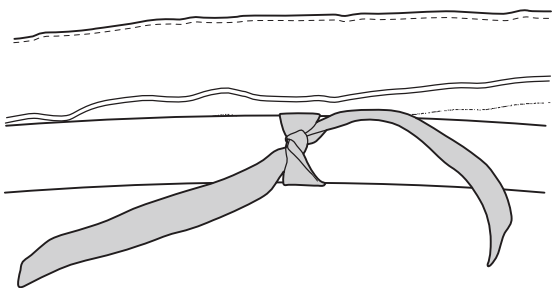
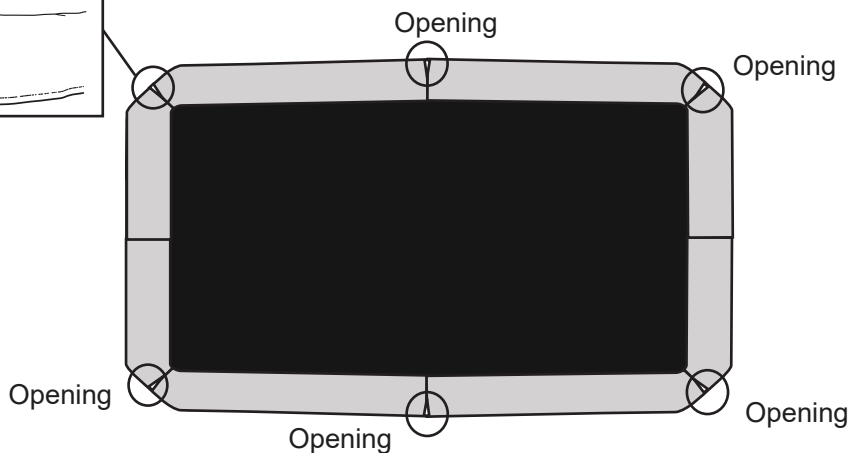

Tie the outer elastic straps on the underside of the frame pad around the top tubes of the frame.

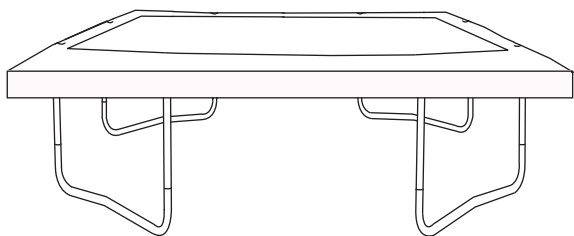

The frame pad is now fitted and you have completed step 4.

WARNING: The trampoline **MUST NOT** be used during construction.

STEP 5 : FITTING THE ENCLOSURE TUBES

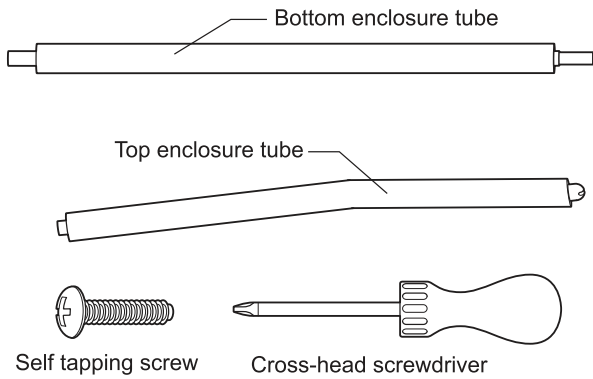

You will need the following parts to complete step 5:

6 x Bottom enclosure tubes - **Part 15**

6 x Top enclosure tubes - **Part 16**

6 x Self tapping screws - **Part 17**

You will also need a cross-head screwdriver (*not supplied*).

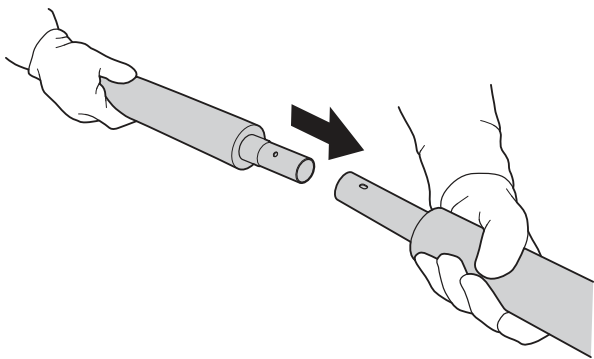

Slot the thin end of one of the bottom enclosure tubes into the open end of one of the top enclosure tubes.

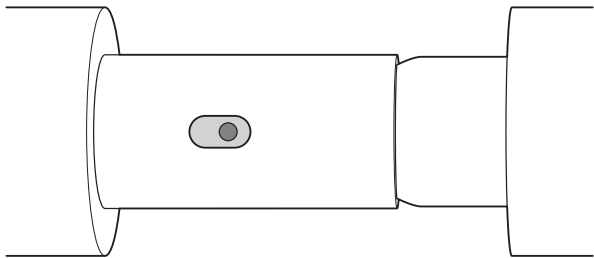

Align the hole in the bottom enclosure tube with the slot in the top enclosure tube.

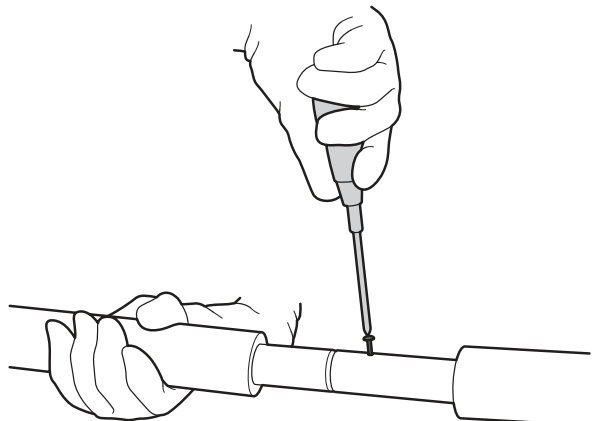

Screw one of the self tapping screws through the slot in the top enclosure tube and into the hole in the bottom enclosure tube using the cross-head screwdriver.

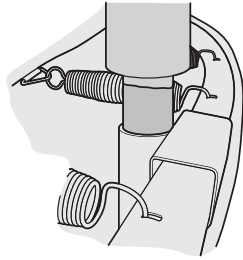
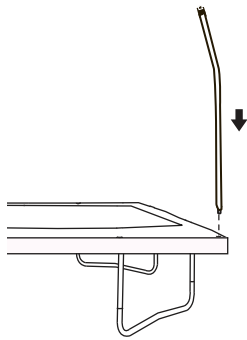

Slot the bottom enclosure tube into the tubes in the T-connector+welded tubes visible through the slots in the frame pad.

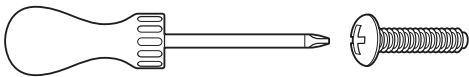
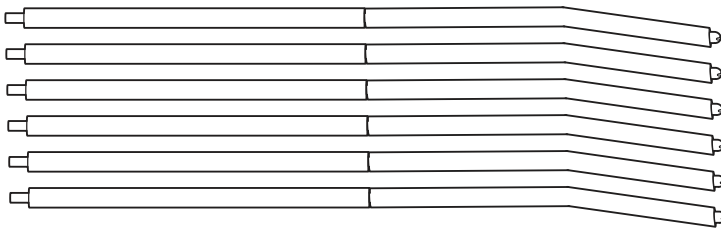

Assemble the five remaining enclosure tubes using the five remaining self tapping screws and the cross-head screwdriver.

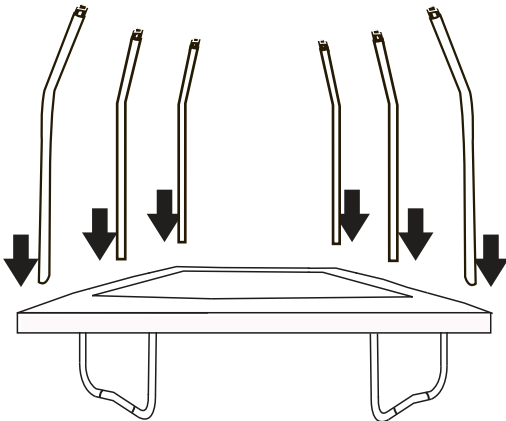

Slot the eight enclosure tubes into the T-connector+welded tubes on the frame.

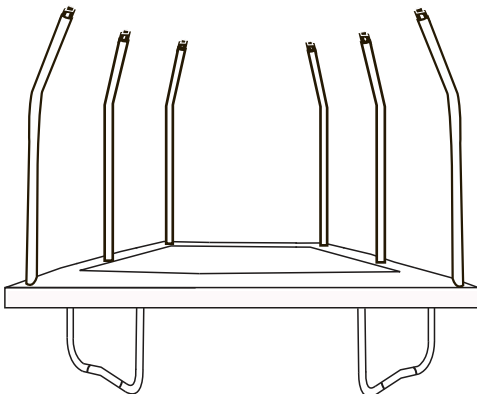

The enclosure tubes are now fitted and you have completed step 5.

STEP 6 : FITTING THE ENCLOSURE NETTING

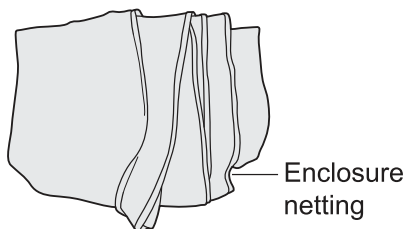

You will need the following parts to complete step 6:

1 x Enclosure netting - **Part 19**

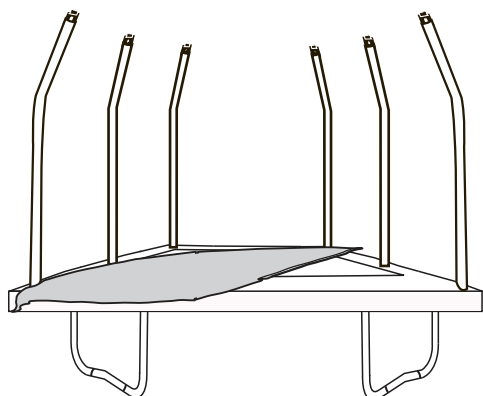

Lay the enclosure netting out on the trampoline.

Please note the zipper entrance is facing on 7ft short side of trampoline.

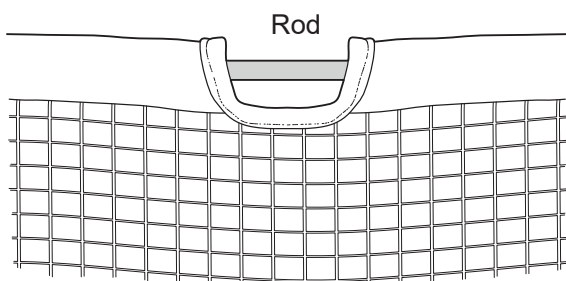

Find the ROD on top of enclosure netting.

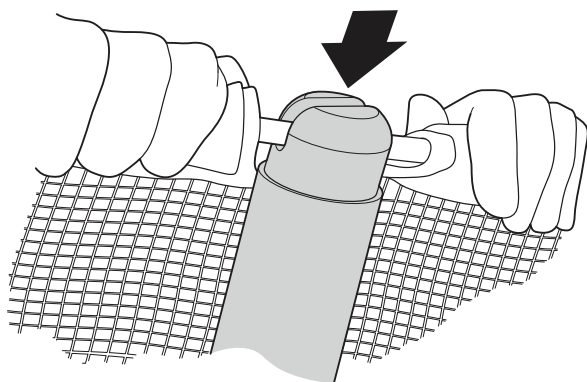

Stand on the trampoline and insert one of the exposed sections of the rod into a plastic grip on top of one of the enclosure tubes.

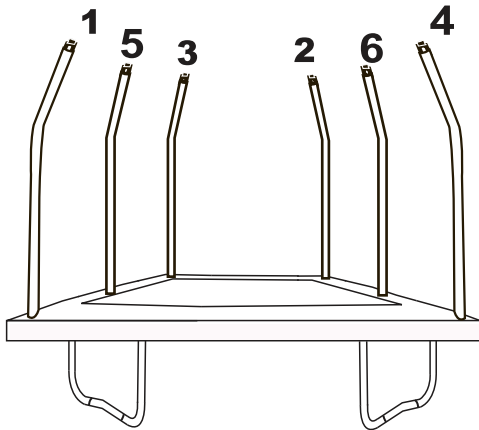

Attach the five other exposed sections of the FRP rods to the other enclosure tubes in the order shown in the diagram.

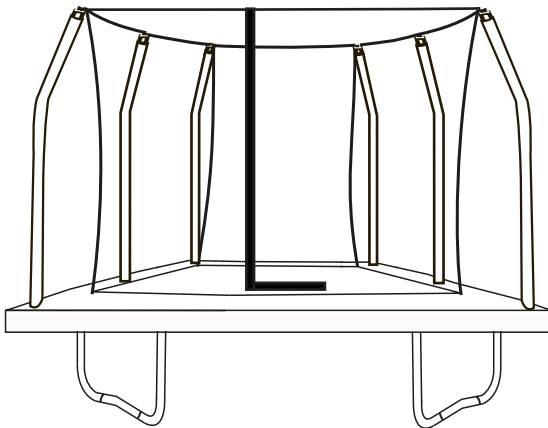

The enclosure net is now fitted and you have completed step 6.

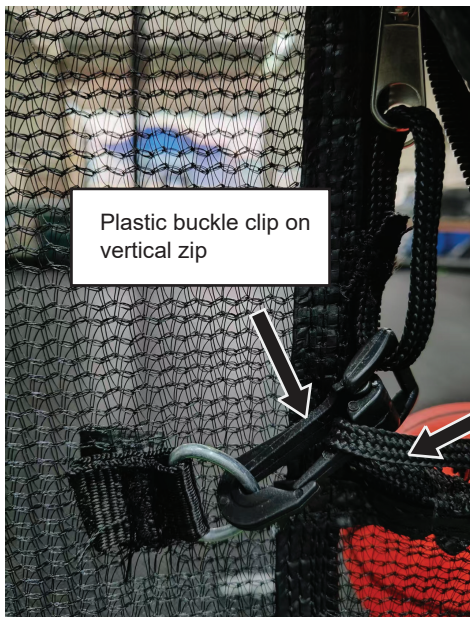

Plastic buckle clip on vertical zip

Rope loop on horizontal zip

There is only one plastic buckle clip on the vertical zipper entrance and one rope loop on the horizontal zipper.

To lock the door, please put the rope loop into plastic buckle clip then lock into D-ring.

STEP 7 : ATTACHING THE BOTTOM OF THE NET

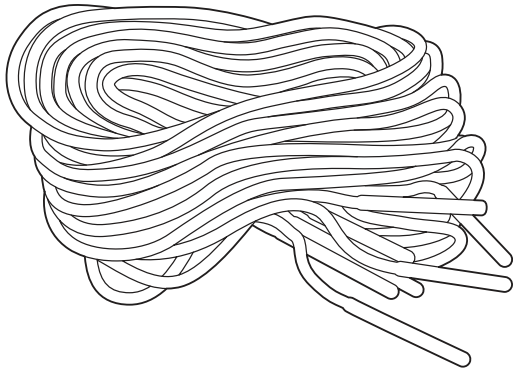

You will need the following parts to complete step 7:
6 x Cords - **Part 20**.

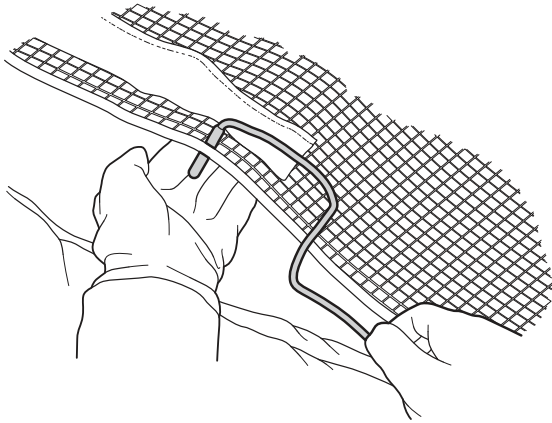

Tie the end of the cord around a V-ring. Push the end of cord through a hole in the bottom of the netting.

Important: Keep the cord tight at all times.

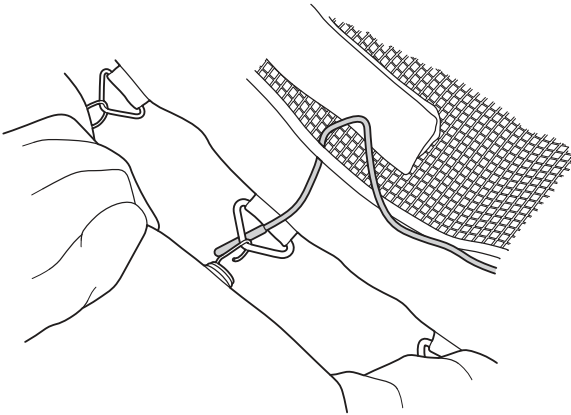

Slot end of the cord through the middle of the next V-Ring along.

Now slot the end back through the net and down through the next V-Ring. Continue to do this until you have used up nearly all the cord then tie this end around a V-Ring.

Tie another cord to this V-Ring and continue until all of the net is tied down.

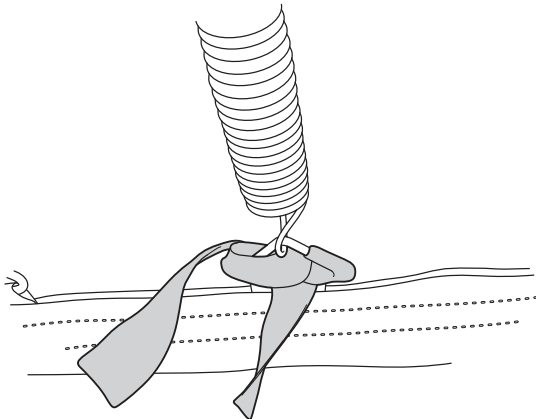

From the underside of the trampoline, tie the remaining elastic straps around the springs or through the V-Rings.

You have completed step 7 and the trampoline is fully assembled.

ASSEMBLE THE TRAMPOLINE LADDER



Put the trampoline ladder - Part 24 onto the top tube facing on zipper entrance.

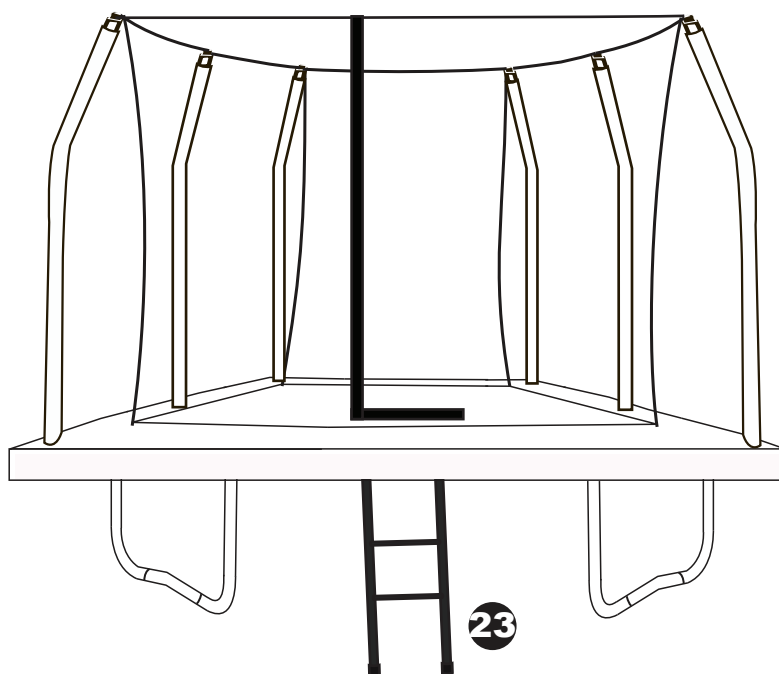

USING THE TRAMPOLINE

Before using your trampoline, check again that there is enough clearance around it. Maintain a clear space of 2.5 metres (8.2 feet) on all sides of the trampoline.

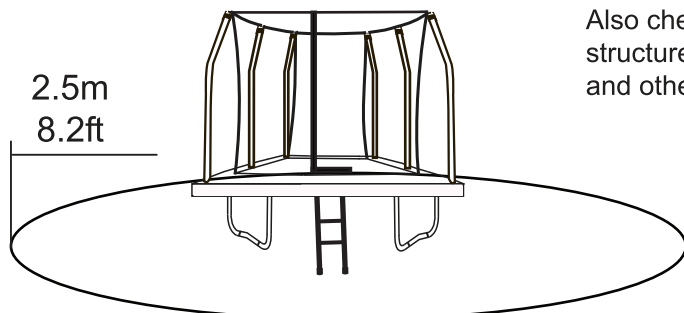

Also check that the area is free from walls, structures, fences, tarmac and other hard surfaces and other play areas.

7.3m 24ft Ensure that there is 7.3 metres (24 feet) clearance above the trampoline.

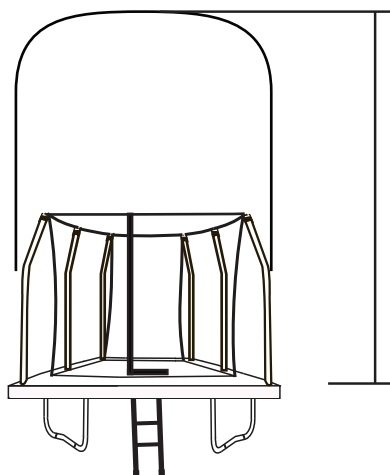

Also check that there are no overhanging objects in the area above the trampoline.

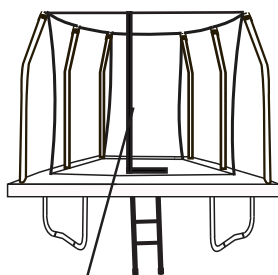

Door
zip

To enter the trampoline, unzip the door and climb in.

Always close the doorway before using the trampoline.

CARE AND MAINTENANCE

CARE

Do not allow pets or animals on the trampoline or inside the enclosure, as claws may snag and pull the bed material or damage the frame pad or netting.

The trampoline/enclosure is intended to be used by one person at a time weighing 90 kg (200 lbs.) or less. The user should be either barefoot, or wearing gymnastic shoes.

Street shoes or tennis shoes should not be worn on the trampoline. The user should remove all sharp objects from his or her person that may cause injury or damage to the bed. Heavy, sharp, or pointed hard objects should not contact the bed.

Appropriate shoes should be worn inside the enclosure to reduce wear to the bed.

MAINTENANCE

Your trampoline is manufactured using quality materials and crafted to provide you and your family with many years of enjoyment and exercise. Proper maintenance and care will help to prolong the life of the trampoline and reduce the possibility of injury.

Prolonged exposure to the sun, especially ultraviolet rays, will shorten the life of the enclosure fabric. For longer fabric life, store the enclosure when it is not being used. A dry enclosure, properly stored, will provide the longest life of the fabric, sewing, and hardware. Remove the enclosure from the trampoline during harsh weather conditions or during long periods of non-use.

The following guidelines should always be observed.

Inspect the trampoline/enclosure before each use, and replace any worn, defective, or missing parts. The following conditions could represent potential hazards and increase the danger of personal injury:

- a missing, improperly positioned, or insecurely attached frame pad, netting, enclosure tubes, foam sleeves
- punctures, frays, tears, or holes worn in the bed, frame pad, netting, foam sleeves.
- deterioration in the stitching or fabric of the bed, frame pad, netting
- ruptured or missing springs
- a bent or broken frame, leg, enclosure tubes
- a sagging bed, netting
- sharp protrusions on the frame, suspension system, enclosure tubes

If any of these conditions exists, the trampoline should be disassembled or otherwise protected against use until the condition is remedied.

REMOVING AND STORING THE TRAMPOLINE/ENCLOSURE

Make sure that the trampoline/enclosure is dry before removing and storing it. Use caution while removing the tubes due to the weight of the tubes.

Once the enclosure is removed from the trampoline, remove all items from the trampoline bed. Make sure that the bed is clean and that it has no tears or holes. Store the trampoline/enclosure in a safe, dry location.

SPECIAL CONSIDERATIONS

High Wind

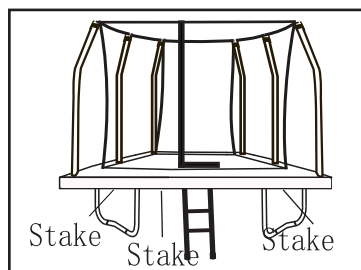

It is possible for the trampoline/enclosure to be blown about by high wind. If you anticipate high winds, the trampoline/enclosure should be moved to a sheltered location, disassembled, or tied down to the ground with ropes and stakes (not included). At least three ropes and three stakes should be used. The tops of the stakes should be at ground level so that they will not create a tripping hazard. In addition, the tops of the stakes should be covered, if necessary, so that users will not be injured by falling onto the stakes. Make sure to attach the ropes to the top of the frame; do not simply secure the legs or the bases to the ground, as they can separate from the frame sockets.

Moving the Trampoline

If the trampoline/enclosure needs to be moved, it should be moved by two persons, kept horizontal, and lifted slightly. If necessary, the trampoline/enclosure can be disassembled for moving.

To disassemble the trampoline/enclosure, follow the assembly steps in reverse order (see pages 17 to 28). Do not attempt to disassemble the frame sections, legs, or bases before the bed and springs have been removed.