

JUMP KING® BACKYARD

**MODEL: JKBK3IN1
3 in 1 Trainer**

OWNER'S MANUAL

ASSEMBLY, INSTALLATION, CARE, MAINTENANCE AND USER INSTRUCTIONS

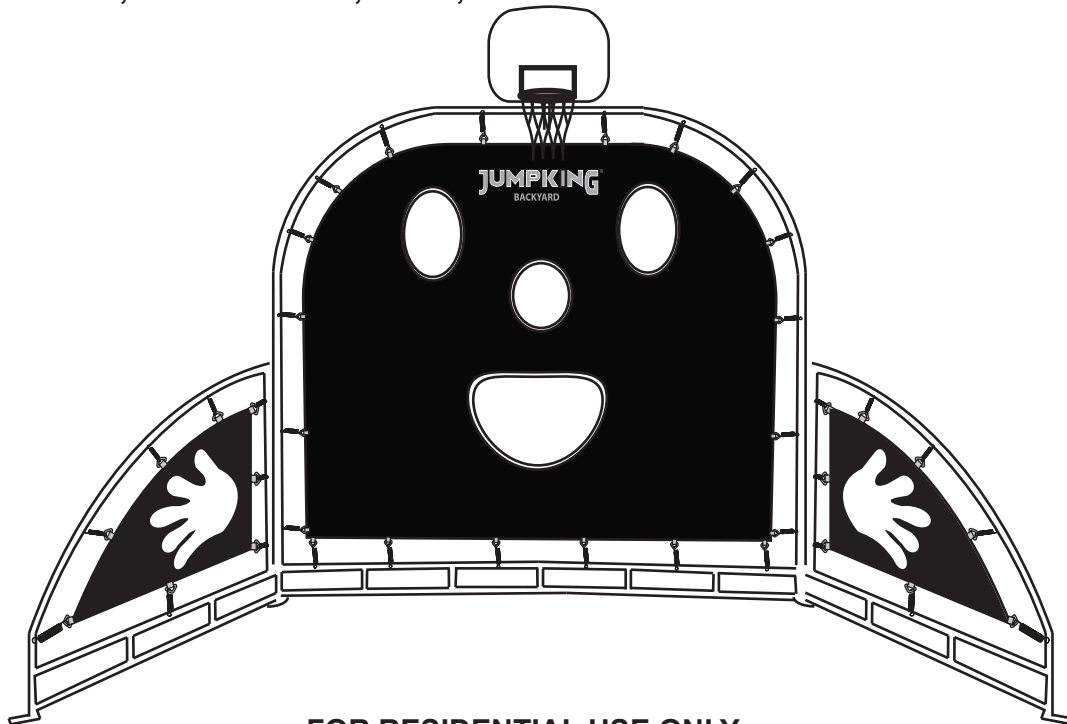

FOR RESIDENTIAL USE ONLY

⚠ WARNING

- The 3 in 1 Trainer is designed to be used by children ages 6+.
- Carefully read this entire instruction manual before you start to assemble or use the 3 in 1 Trainer.
- You must follow all instructions and warnings while using the 3 in 1 Trainer.
- The 3 in 1 Trainer must be anchored. You should consult your local contractor regarding the best way to anchor the 3 in 1 Trainer at your location of installation.
- Assembly requires at least two adults.

Save this instruction manual for future reference

For Customer Service, please call 1-877-927-8777 or visit www.jumpking.com
Monday – Friday 9:00 AM – 5:00 PM Central Time

TABLE OF CONTENTS

IMPORTANT INSTRUCTIONS AND WARNINGS	3 - 4
CARE AND MAINTNENANCE CHECKLIST	5
TOOLS NEEDED	6
PARTS LIST	7 - 9
ASSEMBLY AND INSTALLATION INSTRUCTIONS	10 - 15
ANCHORING	16
WARRANTY	17

IMPORTANT INSTRUCTIONS AND WARNINGS

Jumpking Backyard 3 in 1 Trainer (Basketball, Football, Soccer) Model: JKBK3IN1

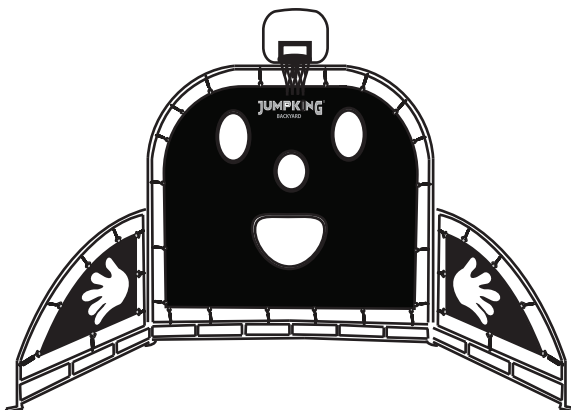

WARNING

To avoid injury during assembly, disassembly, use, adjustment and/or movement of the Jumpking Backyard 3 in 1 Trainer, the following warnings MUST be observed at all times:

- Adult assembly (2 adults) required to assemble, disassemble, adjust or move the 3 in 1 trainer.
- Adult supervision during use is recommended.
- Extreme caution should ALWAYS be exercised when assembling, disassembling, using, adjusting, moving or locating the Jumpking Backyard 3 in 1 Trainer. Children under the age of 12 should not move the 3 in 1 trainer or handle steel ground stakes.
- **WARNING: NEVER** climb on or hang from the Jumpking Backyard 3 in 1 Trainer.
- An adult should ALWAYS anchor the Jumpking 3 in 1 Trainer as instructed prior to use. An unsecured trainer can serious injury.
- Springs are under tension during assembly, use and disassembly. They must be attached and/or detached carefully.
- The Jumpking 3 in 1 Trainer should be placed on a flat surface that is suitable for play while ensuring maximum user safety. Placing on uneven or sloped surface can lead to injury.
- Do not leave the Jumpking Backyard 3 in 1 Trainer outdoors in inclement weather as moisture and other elements may adversely affect the performance of the unit. Do not use in severe weather.
- To extend the life of the product, unit should be stored indoors when not in use. Net and rebounder/trainer should be removed during extended storage.
- Ensure all components are properly assembled prior to use. Examine your Jumpking Backyard 3 in 1 Trainer regularly for wear and tear. Discontinue use immediately if any defect damaged parts are found.
- Keep away from fire and heat sources.

WARNING:

CHOKING HAZARD - Small parts Not for children under 3 years.

Unassembled parts may be a choking hazard for children 3 years and younger. Adult assembly is required. Children should not put arms, head or other body parts in holes in rebounder or net. Entrapment and/or strangulation can occur.

Failure to follow the above mentioned Warnings may result in serious injury.

WARNINGS ON ANCHORING

The product must be anchored into the ground to prevent movement and to make the product more stable during use.

Some consumers want an anchoring system that allows the product to be moved to different locations. Other consumers want to keep their product in a permanent location.

There are different types and different methods of anchoring this product. Jumpking does not make a specific anchoring recommendation as each consumer's need and conditions can vary.

It is highly recommended that you seek the opinion from a local licensed contractor on the best way to secure the product in your location. Whatever method you prefer for your location, an anchoring system for this product should be used at all times.

All anchoring devices must be placed below the level of the playing surface to prevent tripping or injury resulting from a fall.

WEATHER CONDITIONS

- Please be aware of weather conditions when using the equipment.

The product must be properly anchored, stored away or restricted from use during inclement weather such as heavy winds or severe weather storms. You should consult a local contractor about ways to anchor the product at your location.

PLAY SUPERVISION

- DO NOT allow children to walk too close to product. ALWAYS keep a safe distance to avoid being struck by other children while using the product.

- DO NOT allow children to climb on structural parts (e.g. legs, top bar). These are structural components and are not designed for play.

- ALWAYS prevent access and secure from any unauthorized use when there is no adult supervision.

DO NOT allow pets or other animals near the equipment to prevent damage or injuries.

INSPECTION PRIOR TO EACH USE OR DAILY INSPECTION

- DO NOT use the equipment if any bolts or nuts are missing or loose. ALWAYS check to ensure the equipment and all parts are well secured and stable before each use.

- ALWAYS clear the play area of any rocks, sharp objects or any materials that could be potentially hazardous to users.

- DO NOT attach items to the equipment that are not specifically designed for use with the equipment, including, but not limited to, jump ropes, clothesline, pet leashes, cables and chains as they may cause choking hazards.

- The steel parts used in your product are subject to normal wear. Gradual deterioration of the material will occur, the speed of which will depend on the level of exposure to UV rays, airborne pollution, outdoor weather conditions such as rain and wind and the amount of use. You must inspect the equipment prior to every use. This includes, but is not limited to inspecting the product for cracks, excessive wear, missing parts, loose connections and for overall integrity.

When the Jumpking Backyard 3 in 1 Trainer shows any signs of weakness, you must stop using the product immediately, properly store the set or restrict access by users until the condition is resolved.

CARE & MAINTENANCE INSTRUCTIONS

- Inspect all nuts and bolts twice monthly during the usage season for tightness and tighten as required. It is particularly important that this procedure is followed at the beginning of each season.
- Oil all metallic moving parts monthly during the usage period.
- If desired, sand rusted areas on metal tubing and repaint using a non-lead-based paint meeting the requirements of Title 16 CFR Part 1303.
- Check all parts monthly during usage season for deterioration. Replacements should be made in accordance with the manufacturer's instructions.
- Check all coverings for bolts and sharp edges twice monthly during usage season to be certain that they are in place and replace when necessary. It is especially important to do this at the beginning of each new season.

At the beginning of each play season:

- Tighten all hardware.
- Lubricate all metallic moving parts per manufacturer's instructions.
- Check all protective coverings on bolts, pipes, edges and corners. Replace if they are loose, cracked or missing.
- Check all moving parts for wear, rust or other deterioration. Replace as needed.
- Check metal parts for rust. If found, sand and repaint using a nonlead-based paint meeting the requirements of 16 CFR 1303.
- Reinstall any plastic parts that were removed for the cold season.

Twice a month during play season:

- Tighten all hardware.
- Check all protective coverings on bolts, pipes, edges and corners. Replace if they are loose, cracked or missing.

Once a month during play season:

- Lubricate all metallic moving parts per manufacturer's instructions.
- Check all moving parts for wear, rust or other deterioration. Replace as needed.
- Remove any plastic parts as specified by the manufacturer and take indoors or do not use.

Disposal Instructions:

- The owner is to disassemble and dispose of the Jumping Backyard 3 in 1 Trainer in such a way that no unreasonable hazards will exist at the time the equipment is discarded.

TOOLS NEEDED

Please gather the following tools prior to assembling this equipment.

TOOLS NOT INCLUDED:

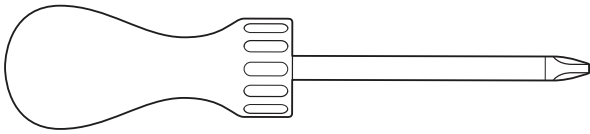

Description:
Phillips head screwdriver

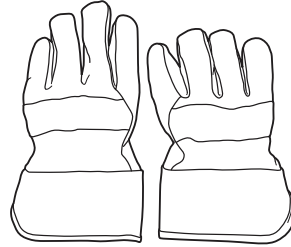

Description:
Gloves

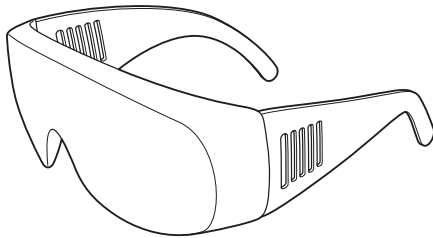

Description:
Safety glasses

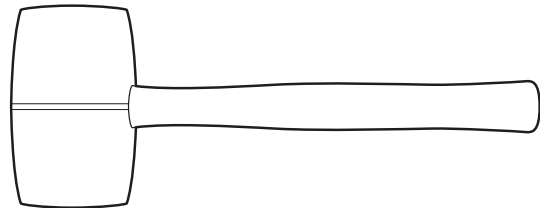









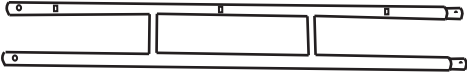
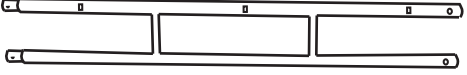

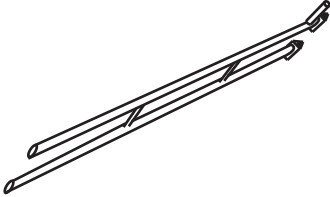

Description:
Mallet
(May be needed for installing anchor)









Description:
Stool or Step ladder







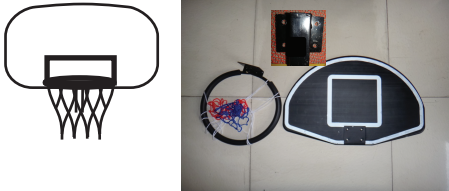
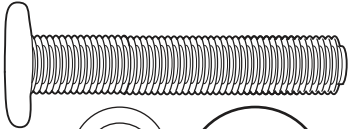
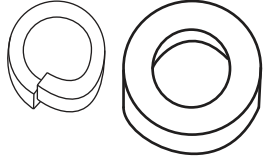
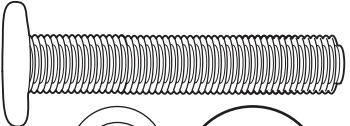
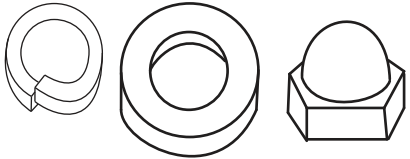

Parts Listing:

Item number	Qty	Description	Picture
1	1	Bottom tubing marking C	
2	1	Bottom tubing marking G	
3	1	Center connector	
4	1	Left connector marking C	
5	1	Right connector marking G	
6	1	Left wing bottom tube marking A	
7	1	Left wing bottom tube connector marking A	
8	1	Right wing bottom tube marking B	
9	1	Right wing bottom tube connector marking B	
10	1	Left wing straight tube marking A	
11	1	Right wing straight tube marking B	
12	1	Left wing top curve tube marking A	
13	1	Left wing bottom curve tube marking A	

Parts Listing:

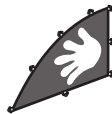
Item number	Qty	Discription	Picture
14	1	Right wing top curve tube marking B	
15	1	Right wing bottom curve tube marking B	
16	1	Front panel straight tube marking C	
17	1	Front panel straight tube marking G	
18	1	Front panel curve tube marking D	
19	1	Front panel curve tube marking F	
20	1	Top 4 way connector marking E	
21	1	<p>Basketball hoop (Basketball board - 1 pc, Hoop - 1 pc, Accessories - 1 set, and screw set as following)</p> <p>Description: 1) 15mm x 8mm Screw (C) - 1 set 2) 18.23mm dia x 8.11mm inner dia Washer 3) 12.75mm dia x 8.34mm inner dia Spring washer 4) 15.44mm dia x 14.51mm inner dia Nut</p> <p>Description: 1) 30mm x 8mm Screw (D) - 4 sets 2) 18.23mm dia x 8.11mm inner dia Washer 3) 12.75mm dia x 8.34mm inner dia Spring washer 4) 15.44mm dia x 14.51mm inner dia Nut</p>	    

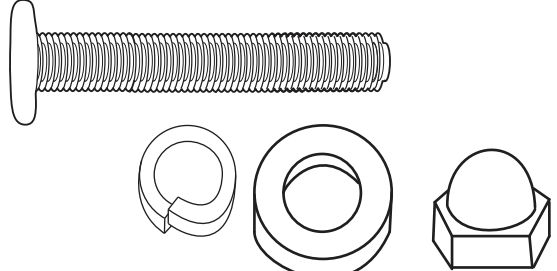
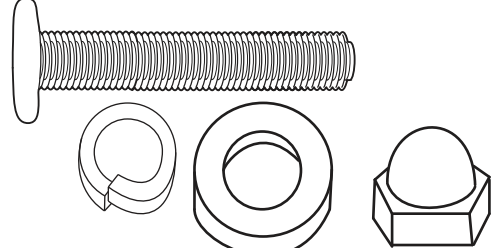
Parts Listing:

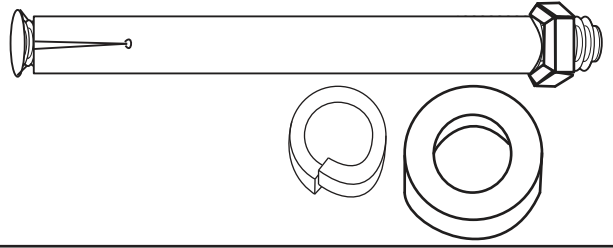
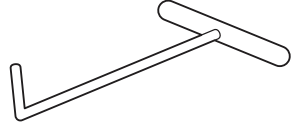
Item number	Qty	Discription	Picture
22	1	Back support pole top	
23	1	Back support pole bottom	
24	1	Back support foot pad	
25	36	Spring	
26	1	Front panel	
27	1	Left wing panel	
28	1	Right wing panel	
29	6	<p>Set of 8mm x 50mm Screw</p> <p>Description:</p> <ol style="list-style-type: none"> 1) 50mm x 8mm Screw (A) 2) 18.23mm dia x 8.11mm inner dia Washer 3) 12.75mm dia x 8.34mm inner dia Spring washer 4) 15.44mm dia x 14.51mm inner dia Nut <p>Quantity: 6 sets</p>	
30	2	<p>Set of 8mm x 40mm Screw</p> <p>Description:</p> <ol style="list-style-type: none"> 1) 40mm x 8mm Screw (B) 2) 18.23mm dia x 8.11mm inner dia Washer 3) 12.75mm dia x 8.34mm inner dia Spring washer 4) 15.44mm dia x 14.51mm inner dia Nut <p>Quantity: 2 sets</p>	
30	4	Metal pegs	
31	3	<p>Set of Hex nut screws</p> <p>Description:</p> <ol style="list-style-type: none"> 1) 78mm x 8mm Hex nut screw 2) 18.23mm dia x 8.11mm inner dia Washer 3) 12.75mm dia x 8.34mm inner dia Spring washer 4) 15.44mm dia x 6.17mm inner dia Nut <p>Quantity: 3 sets</p>	
32	1	Spring pulling tool	

Step 1 - Assemble the base frame

1.

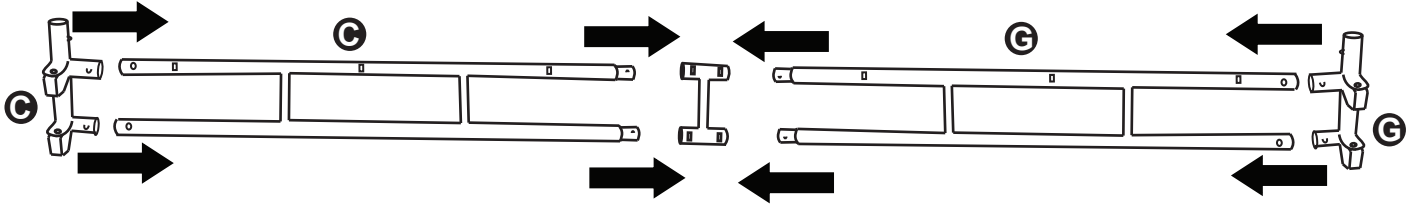

2.

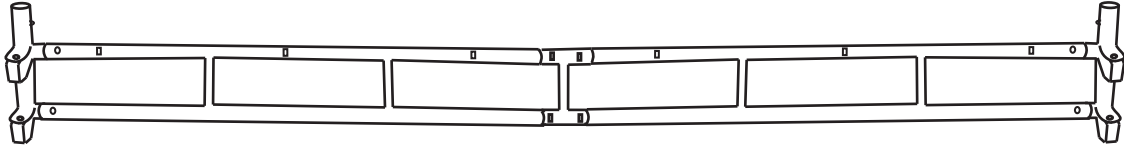

3.

8mm x 50mm Screws (A) 4 pcs

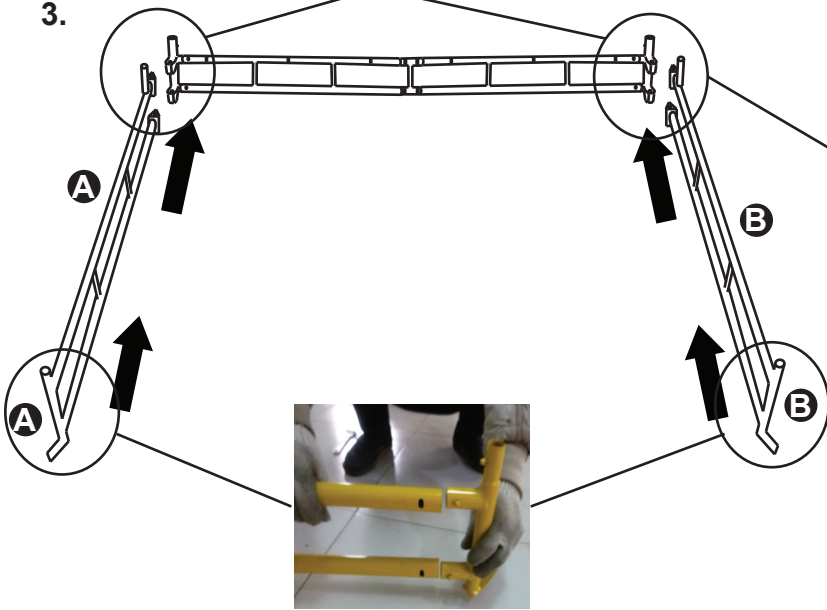

4.

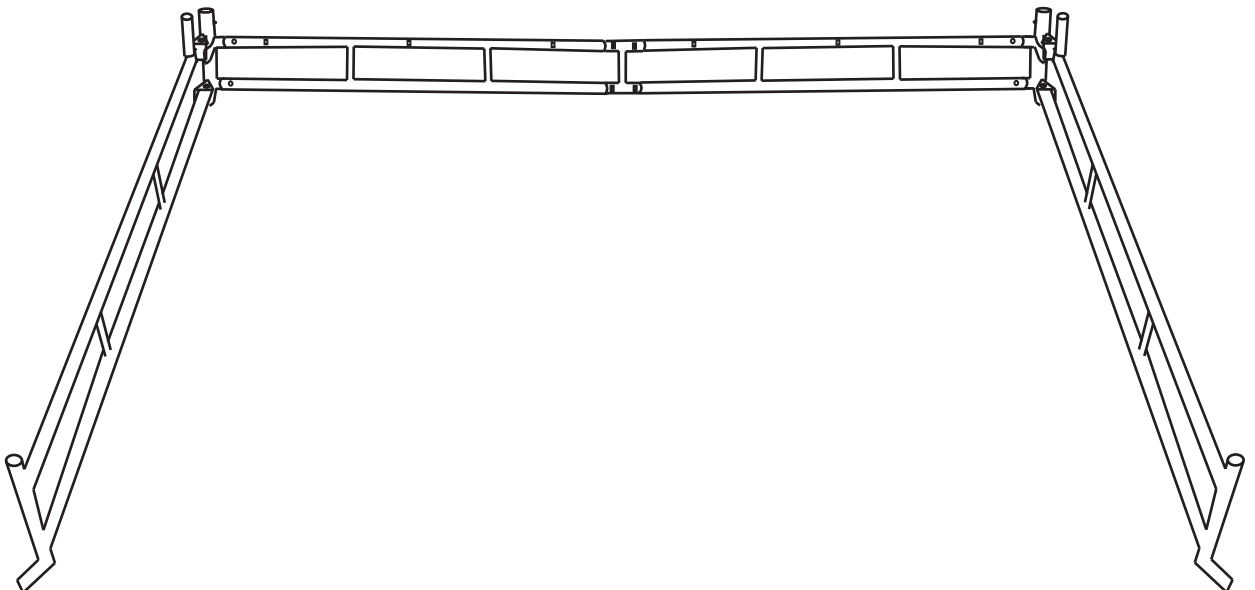

Step 2 - Assemble the wings

5.

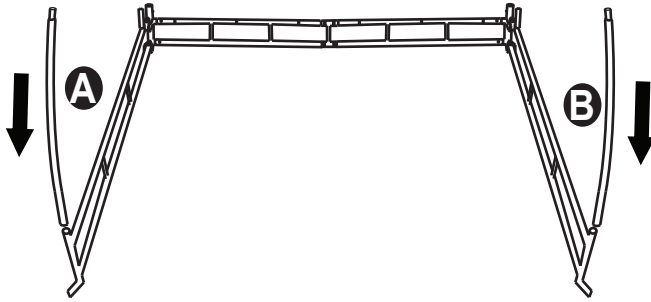

6.

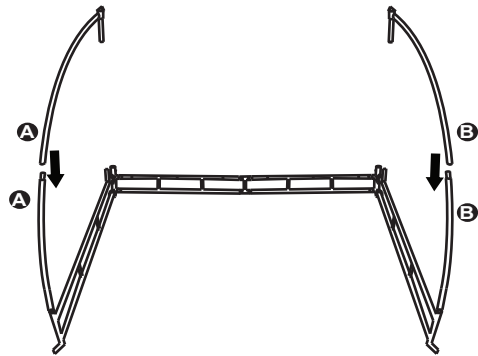

7.

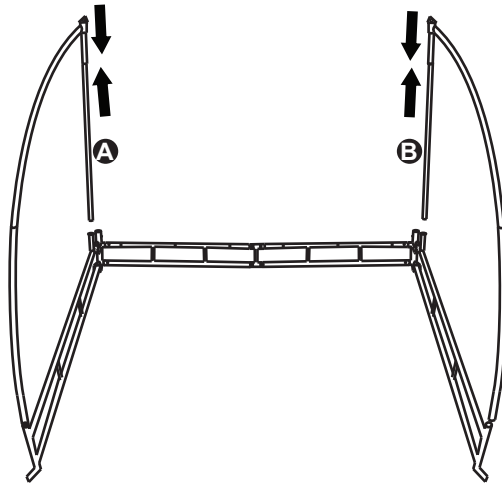

8.

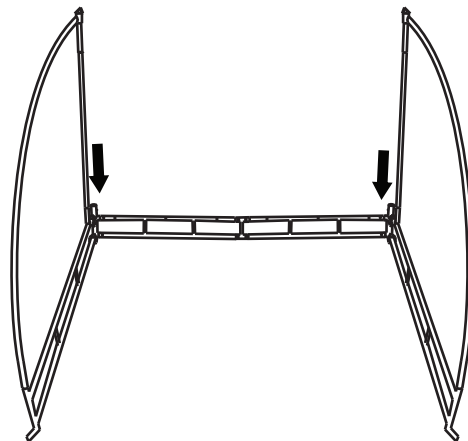

Step 3 - Assemble the main frame

9.

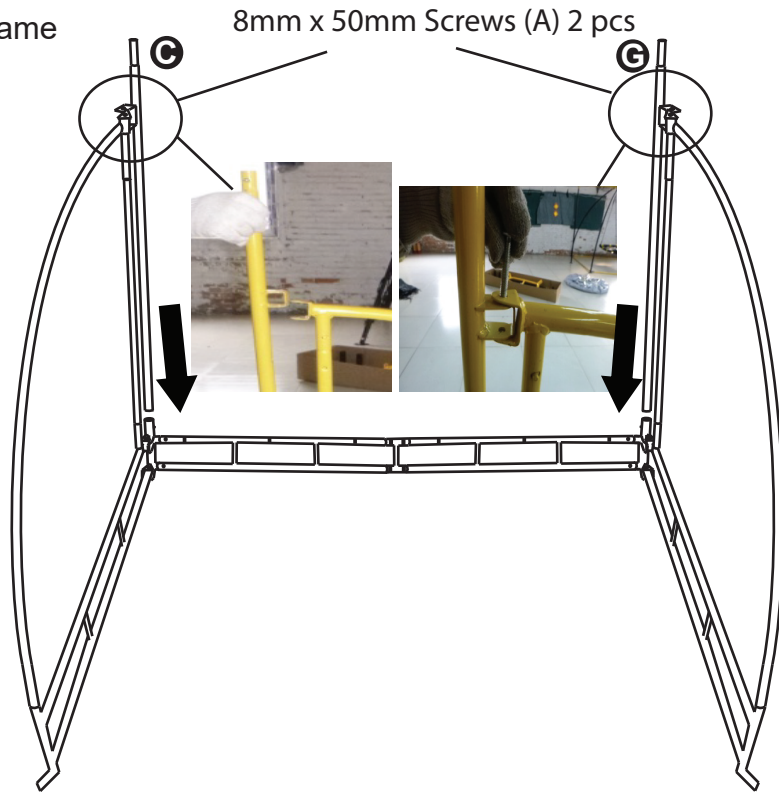

10.

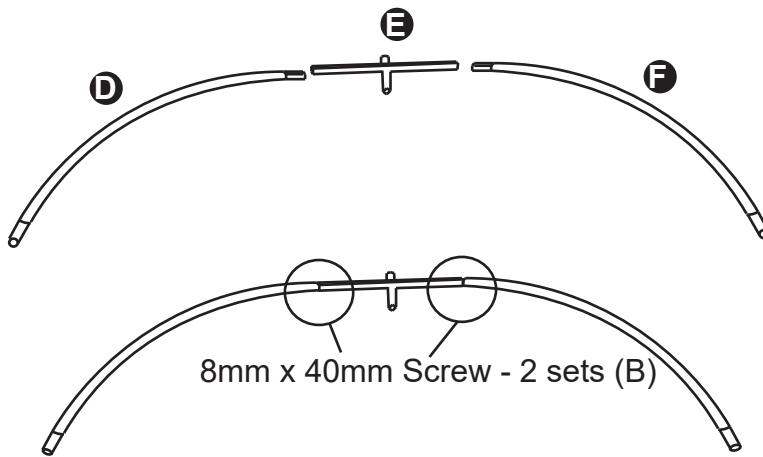

11.

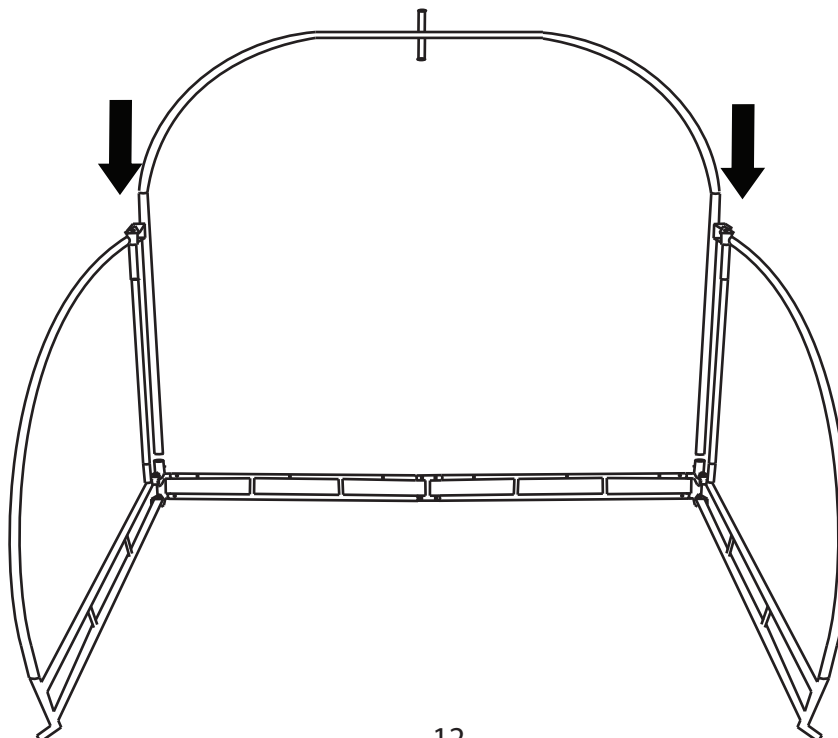

Step 4 - Assemble the Basketball hoop

12.

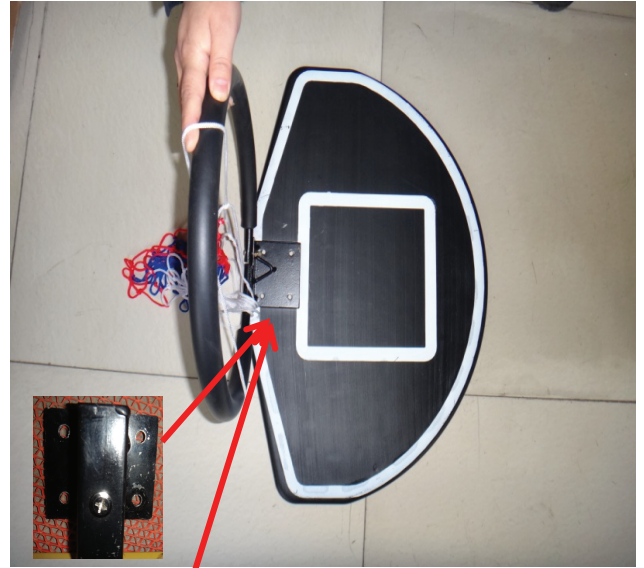
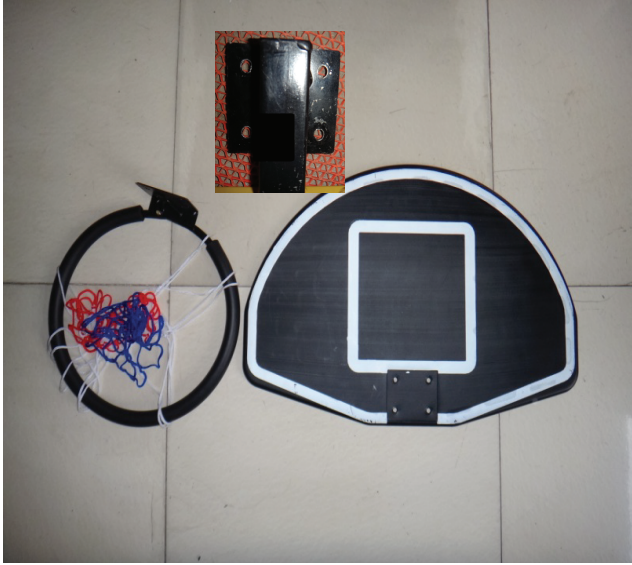

On back side of
basketball board

Use 8mm x 30mm Screws - 4 sets (D)

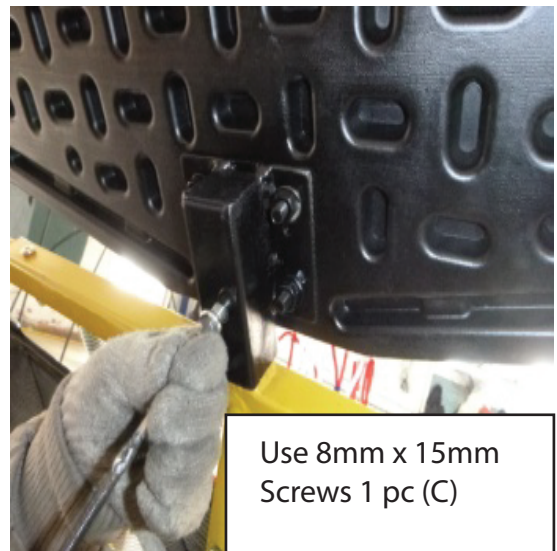

Use 8mm x 15mm
Screws 1 pc (C)

13.

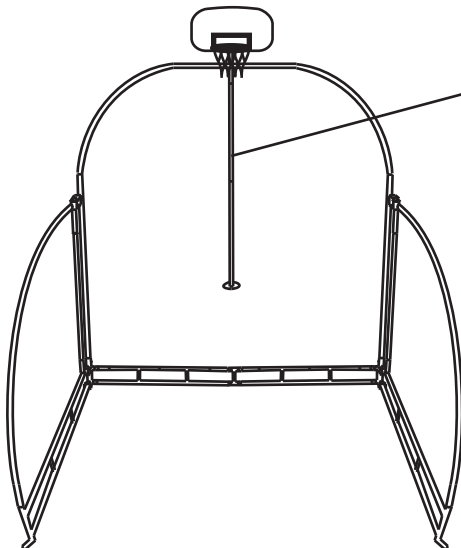

Set up the back support pole
(Part 22, 23, 24)

Step 5 - Assemble the Front panel

14.

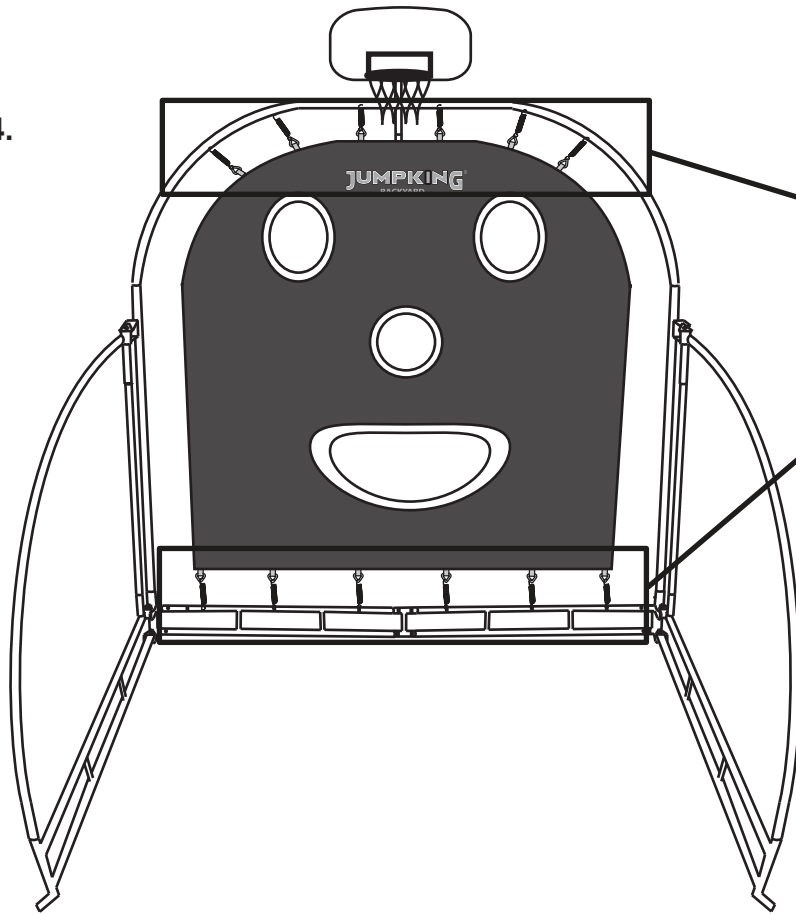

Install the top and bottom springs to the tubing by using Spring pulling tool (31).

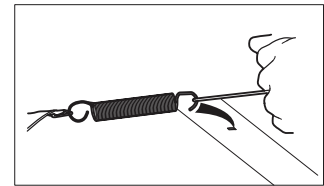

Hook the spring tool onto end of spring, and pull until the spring can be slotted into the spring slot on the frame.

IMPORTANT: Ensure the spring is fully inserted into the slot on the frame.

15.

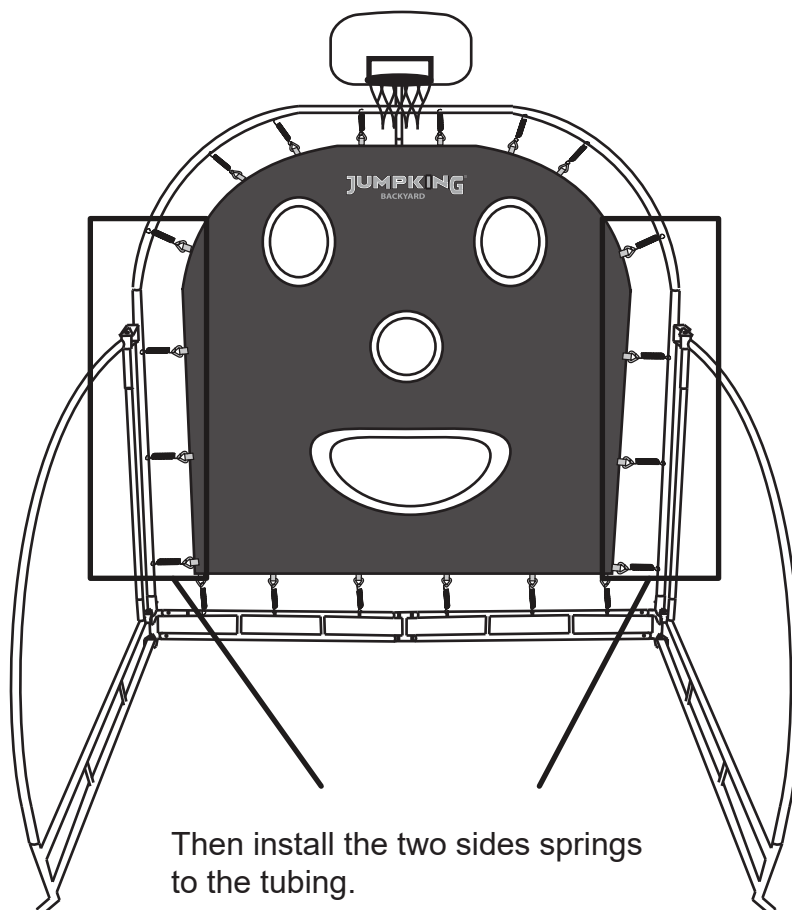

Then install the two sides springs to the tubing.

Step 6 - Assemble the springs to 2 side wing panels

16.

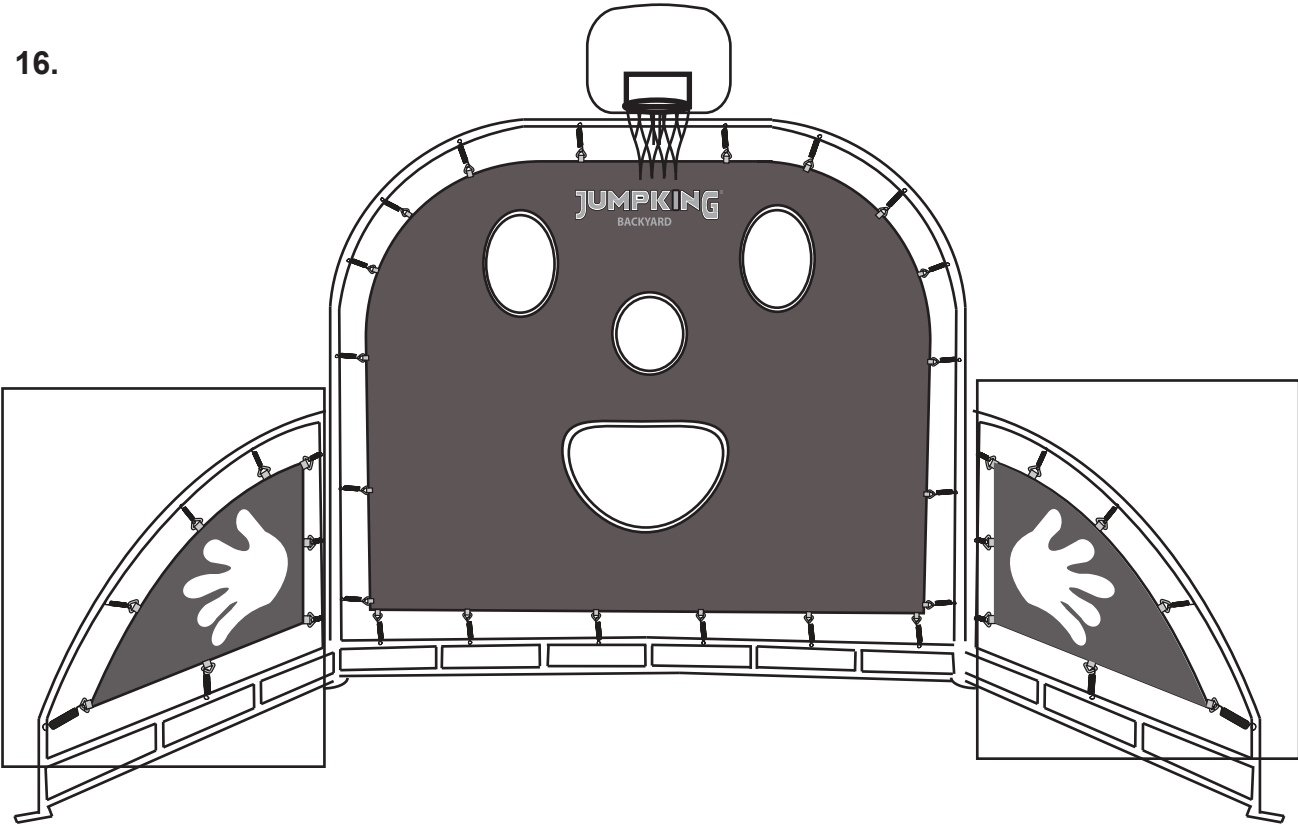

Step 7 - Anchoring the frame

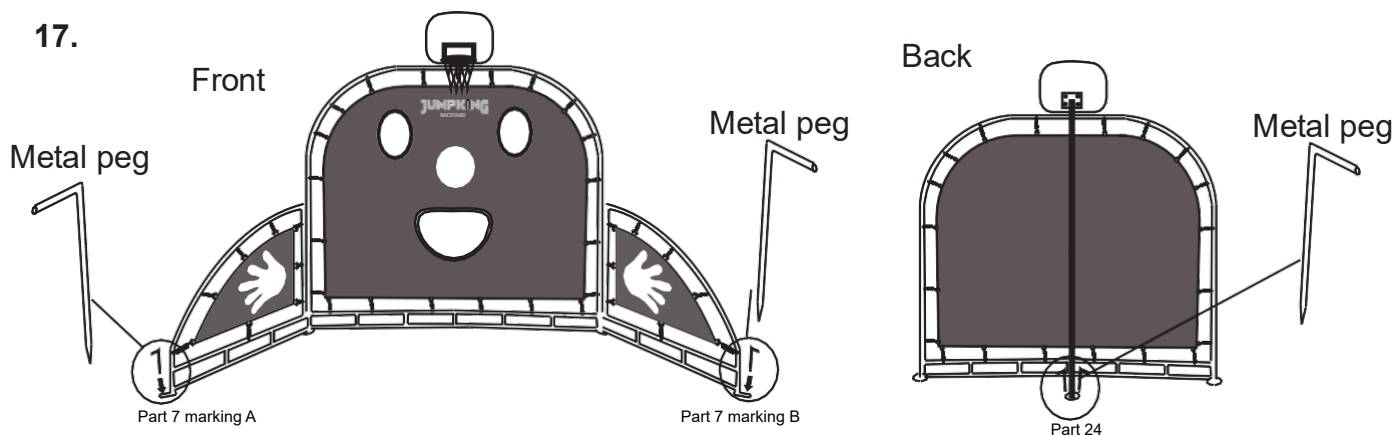

The following anchoring options may be considered:

Metal Peg

- If your soil is hard (clay, etc.), the metal peg may be suitable.
 - Be sure that the product is located on level ground.
 - Use the hammer to knock down the metal peg into the ground until only the end with the hook is above the ground and next to the leg. Insert the hook into the bottom opening of the leg.
- Ensure that the hook is secured onto the leg opening.

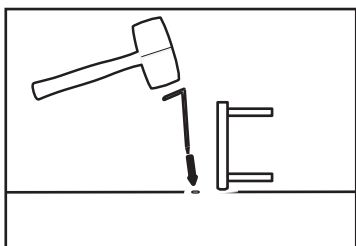

Hex Nut Screw (For permanent installation)

- Ground with sandy soil (soft) condition, it must be anchored with concrete footing (concrete not included)
 - Be sure that the product is assembled and placed on level ground
 - Dig holes around leg tubes, as shown in drawing above. As you dig deeper, enlarge the diameter of the hole to fill with cement
 - Place 2 inches of brick or gravel underneath the leg.
 - Use about 45 lbs. of concrete per leg
 - Cover the concrete with dirt and protective surface material
- Allow 6-7 days for the concrete to dry properly

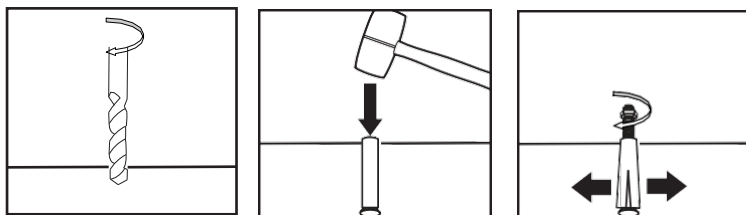

WARNING

Please properly anchor the product to minimize the risk of injury or death.

If the product is used without proper anchoring, it could be dangerous and may cause injury.

WARRANTY

Limited Warranty YJ (USA) CORP.

YJ (USA) CORP. warrants its trampoline products to be free from defects in material and workmanship under normal use and service conditions. The various components of the trampoline/enclosure are warranted against defects and workmanship for the time periods specified as follows:

Steel Frame: 1 Year

Sewing and all Other Parts: 6 Months

www.jumpking.com

www.jumpod.com

Customer Service Toll Free No. 1-877-927-8777

3970 Lindbergh Drive, Addison, TX 75001

Monday – Friday

Hours: 9am – 5pm CT

All warranty coverage extends only to the original retail purchaser from the date of purchase. YJ (USA) CORP. obligation under this Warranty is limited to replacing or repairing, at YJ (USA) CORP. option, the product at one of its authorized service centers. All products for which a warranty claim is made must be received by YJ (USA) CORP. at one of its authorized service centers and accompanied by sufficient proof of purchase (photocopy of the original store receipt, indicating the date of purchase). All freight and handling fees are the responsibility of the consumer to pay, both to and from YJ (USA) CORP.. All warranty claims must be preauthorized by YJ (USA) CORP.. Preauthorization can be obtained by calling 877-927-8777. This warranty does not extend to any product or damage to a product caused by or attributable to freight damage, abuse, misuse, improper or abnormal usage, or repairs not provided by a YJ (USA) CORP. authorized service center or for products used for commercial or rental purposes. This warranty does not cover ordinary wear and tear, weathering, failure to follow directions, improper installation, improper maintenance, or acts of Nature (such as damage caused by wind, lightning, snow, water, or ice). No other Warranty beyond that specifically set forth above is authorized by YJ (USA) CORP..

YJ (USA) CORP. IS NOT RESPONSIBLE OR LIABLE FOR INDIRECT, SPECIAL OR CONSEQUENTIAL DAMAGES ARISING OUT OF OR IN CONNECTION WITH THE USE OR PERFORMANCE OF THE PRODUCT OR OTHER DAMAGES WITH RESPECT TO ANY ECONOMIC LOSS, LOSS OF PROPERTY, LOSS OF REVENUE OR PROFITS, LOSS OF ENJOYMENT OR USE, COST OF REMOVAL, INSTALLATION OR OTHER CONSEQUENTIAL DAMAGES. SOME STATES DO NOT ALLOW THE EXCLUSION OR LIMITATION OF INCIDENTAL OR CONSEQUENTIAL DAMAGES. ACCORDINGLY, THE ABOVE LIMITATION MAY NOT APPLY TO YOU.

THE WARRANTY EXTENDED HEREUNDER IS IN LIEU OF ALL OTHER WARRANTIES AND YJ USA SPECIFICALLY DISCLAIMS ANY IMPLIED WARRANTY OF MERCHANTABILITY OR FITNESS FOR A PARTICULAR PURPOSE IS LIMITED IN ITS SCOPE AND DURATION TO THE TERMS SET FORTH HEREIN. SOME STATES DO NOT ALLOW LIMITATION ON HOW LONG AN IMPLIED WARRANTY LASTS. ACCORDINGLY, THE ABOVE LIMITATION MAY NO APPLY TO YOU.

This warranty gives you specific legal rights. You may also have other rights, which vary from state to state.